

# CRANBOURNE STONE

EST 2004

*The Swimming Pool Surround  
and Landscape specialists*

## About Us...

Having built prestigious swimming pools for over 20 years for the family swimming pool installation business, Howard, the Managing Director of Cranbourne Stone, recognized the demand for better quality pool surrounds. Understanding the complexity of swimming pool installation, in 2004 Howard and his wife Jo, who had also worked within the swimming pool industry from the age of 18, decided to form Cranbourne Stone Ltd.

Initially making pre-cast (concrete) swimming pool copings, the demand for natural stone grew and after sourcing suppliers worldwide for suitable natural stone for both swimming pools and landscaping projects, Cranbourne Stone are now importing stone from over 10 countries world-wide.

To keep up with the ever-changing trends, in 2015 the company introduced its first 20mm thick Porcelain, which has now become as popular as the natural stone. Cranbourne are now working with 11 Italian porcelain factories, which has enhanced their product range tenfold.

Having created a name in the swimming pool industry as the go-to stone company for bespoke pool copings and deck level grilles, Howard & Jo have invested heavily over the years in state of the art machinery, including a CNC 5 axis bridge saw, a 5 axis waterjet machine and most recently a porcelain cutting and edging machine. This has had an overwhelming effect on the business and has allowed them to not only produce more detailed and bespoke projects, but at a much quicker turn-around.

Cranbourne Stone now produce and stock the largest range of swimming pool surrounds in the UK. Understanding that no two projects are the same, Cranbourne are able provide a site-template service, combining this with our technical expertise and hi-tech machinery Cranbourne Stone thrives on a challenge and excels where others can only imagine.

Their relationship with their customers is of the highest importance to Howard & Jo. After 14 years running their family business, they are truly thankful for the continued support from loyal customers and look forward to continuing and growing relationships with both old and new customers nationwide for years to come.



In memory of dear friends  
and family Cranbourne Stone Ltd  
Support Ovarian Cancer Action.



## Ethical Trading

Cranbourne Stone Ltd are proud supporters of the Ethical Trading Initiative ensuring that all products are produced in the most suitable working environment possible.

The Ethical Trading Initiative (ETI) is an alliance of companies non-governmental organisations (NGOs) and trade union organisations promoting ethical consumerism. They exist to promote and improve the implementation of corporate codes of practice, which cover supply chain working conditions. Their ultimate goal is to ensure that the working conditions of employees producing for the UK market meet or exceed international labour standards. Underpinning all their work is the ETI Base Code. The Base Code contains nine clauses which reflect the most relevant international standards with respect to labour practices.

We at Cranbourne Stone Ltd feel that everyone has the right to a fair and ethical working environment. It is because of this that all of our products are only sourced from suppliers who support and adhere to the Ethical Trading Initiative and support the Base Code.

## Compliments

In producing this brochure, we would like to thank our customers who kindly provided us with photos of their projects using our stone.

London Swimming Pool Company • Carl Vernon Pools • Bluepools Ltd  
Harlequin Swimming Pools Ltd • Pool Logic Limited • Chiswell Pools Ltd  
A & D Swimming Pools Ltd • Letts Swimming Pools Ltd • XL Pools Ltd  
Cresta Leisure Ltd • Guncast Swimming Pools • Hellard Bros Ltd  
Hamilton Pools • Elm Leisure • E.J Payne • Darryl Young Swimming Pools  
Whitewaters Ltd • Cornwall Pools • Albatross Pools & Spas Ltd • Hambrooks  
The Helyers Group • Paramount Pools • Mermaid Swimming Pools  
RT Swimming Pool Services Ltd • Greener Landscapes • Falcon Pools Ltd  
Design by Katja • Alba / SB Pools Limited

# Contents

## PORCELAIN

<b>Porcelain 20mm Thick</b>	3-14
Boston	5
Verona	7
Garda	9
Namur	11
<b>Porcelain 10mm Thick</b>	17-20

## POOL LINING

15

## NATURAL STONE

<b>Natural Stone Finshes</b>	21
<b>Natural Riven Sandstone</b>	
Cotswold Mint	23
Raj Riven	25
<b>Tumbled Riven Sandstone</b>	
Georgian Antiqued	27
<b>Honed Sandstone</b>	
Danebury	29
<b>Sandblasted Sandstone</b>	
Leckford	31
<b>York Stone</b>	33
<b>Travertine</b>	
Travertine Tumbled & Unfilled	35
<b>Limestone</b>	
<b>NEW</b> Fossil Pearl Tumbled Grip	Page 37
Fossil Pearl Satin	Page 39
Crema Europa	Page 41
Broughton	Page 43
Downton	Page 45

## Marble

Pembury	47
---------	----

## Granite - Basalt

Fullerton Grey	49
Montreal	51
Chattis Black	53

## DECK LEVEL GRILLES

<b>Contemporary</b>	57
<b>Dished</b>	59
<b>2 x Slot Linear</b>	61

## LAPITEC

63

## LANDSCAPING

70

## FREE FORM • BESPOKE • TEMPLATE SERVICE

<b>Gallery</b>	65
<b>Roman End Bays &amp; Corner Dimensions</b>	56
<b>Edging Profiles &amp; Coping Stone Types</b>	55
<b>Site Template Service</b>	67
<b>Pack Types</b>	75
<b>Bespoke Masonry</b>	69
<b>Laying Guides</b>	71
<b>Terms and Conditions</b>	76

### SLIP RESISTANCE RATING:

Potential For Slip	Pendulum Test Value (PTV)	Dry	Wet
High Slip Potential	0 - 24	1	A
Moderate Slip Potential	25 - 35	2	B
Low Slip Potential	36 +	3	C



**FROST RESISTANT**

# Porcelain Range

Porcelain tiles are made from a mix of natural clay and finely ground sand, which is then pressed and fired at a very high temperature. Each design is baked onto the body of the surface of the tile, to create natural looking tiles. Our range includes 10 and 20mm thick tiles with a grip (slip-resistant finish) perfect for external projects, swimming pool surrounds and landscaping projects and 10mm matching tiles with a smoother finish, perfect for internal floor/wall and pool tanks. Not only does the Porcelain create a perfectly contemporary finish to your project it is also highly durable, resistant to moss, mould and easy to keep clean. Utilising our waterjet and profiling machinery we are able to cut and shape porcelain effortlessly.

Full Bullnose edge for steps  
and pool copings



Radius cut with pencil edge for  
pool or step edge



Aco Deck drainage grille



6" radius corner for pool copings

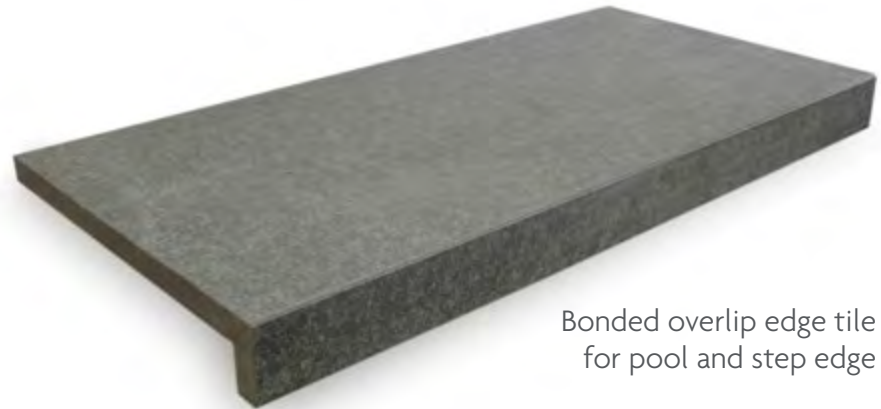

Bonded overlap edge tile  
for pool and step edge



90° corner pool copings

# Boston - Porcelain

This modern porcelain has the look of a natural flamed basalt. If you're looking for a contemporary product for indoor or outdoor use, our Boston porcelain is the perfect choice.

## **Paving/Tiles:**

600 x 600 x 20mm

## **Step Treads:**

with full bullnose

600 x 298 x 20mm

## **Swimming Pool Copings:**

with full bullnose

600 x 298 x 20mm

90° Square & 6" Radius Corners,  
4ft & 5ft Roman Ends are made to order.

*Cut to size and bespoke profile available.*

## **Bespoke:**

Free-form shaped copings and bespoke porcelain is made to measure.



Boston Bespoke steps with Namur paving

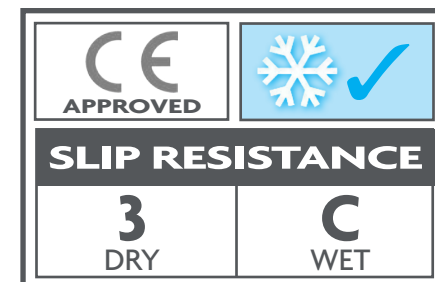
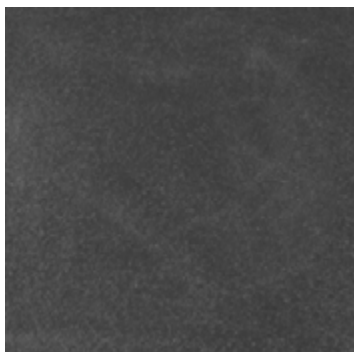



# Verona - Porcelain

Another very contemporary porcelain with a clean and crisp finish. A wonderful alternative to white limestone.

## **Paving/Tiles:**

600 x 600 x 20mm

## **Step Treads:**

with full bullnose

600 x 298 x 20mm

## **Swimming Pool Copings:**

with full bullnose

600 x 298 x 20mm

90° Square & 6" Radius Corners,  
4ft & 5ft Roman Ends are made to order.

*Cut to size and bespoke profile available.*

## **Bespoke:**

Free-form shaped copings and bespoke porcelain is made to measure.

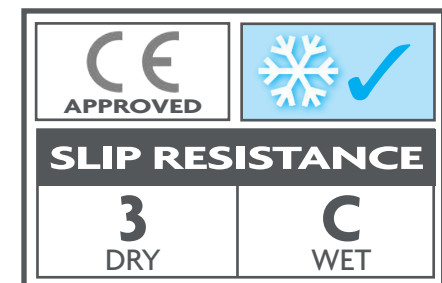





# Garda - Porcelain

Our Garda Porcelain has a modern polished concrete look with subtle tones and highlights of a smokey grey.

## Paving/Tiles:

600 x 600 x 20mm

## Step Treads:

with full bullnose

600 x 298 x 20mm

## Swimming Pool Copings:

with full bullnose

600 x 298 x 20mm

90° Square & 6" Radius Corners,  
4ft & 5ft Roman Ends are made to order.

*Cut to size and bespoke profile available.*

## Bespoke:

Free-form shaped copings and bespoke porcelain is made to measure.

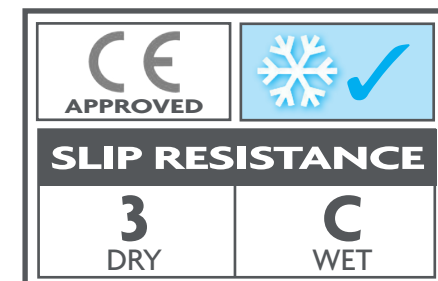



# Namur - Porcelain

Our Namur Porcelain has the look of Belgium Blue Limestone. A very modern look with its dappled grey tones and limestone look.

## **Paving/Tiles:**

600 x 600 x 20mm

## **Step Treads:**

with full bullnose

600 x 298 x 20mm

## **Swimming Pool Copings:**

with full bullnose

600 x 298 x 20mm

90° Square & 6" Radius Corners,  
4ft & 5ft Roman Ends are made to order.

*Cut to size and bespoke profile available.*

## **Bespoke:**

Free-form shaped copings and bespoke porcelain is made to measure.

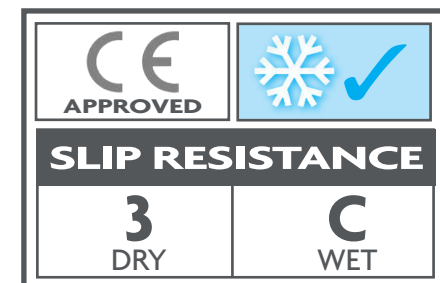



# Porcelain Grip Finish 20mm Range

Suitable for Pool Surrounds and Landscape Projects

## 66 SERIES 600 x 600 x 20mm

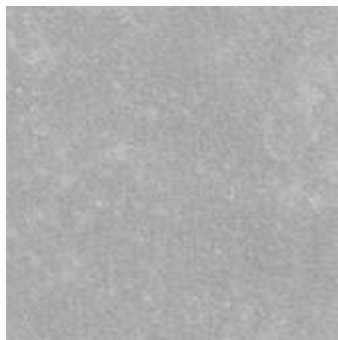

NAMUR LIGHT

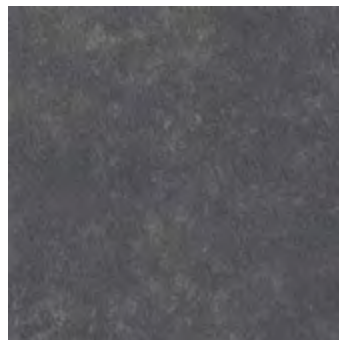

NAMUR DARK



WILTON BEIGE

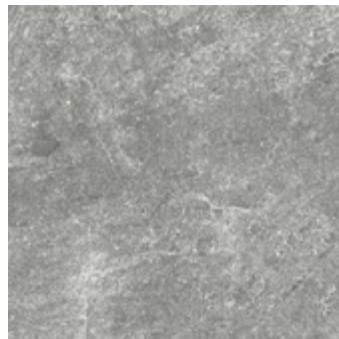

SARUM GREY

### Swimming Pool Copings:

with full bullnose 600 x 298 x 20mm  
 90° Square & 6" Radius Corners, 4ft & 5ft Roman Ends are made to order.  
 Cut to size and bespoke profile available.

## 96 SERIES 900 x 600 x 20mm

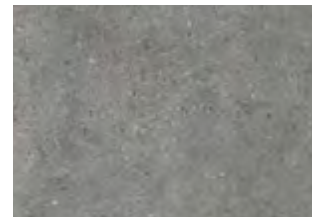

CORFE GREY



STUDLAND

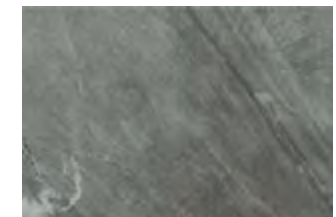

MEON QUARTZ



PORTLAND CREAM



AWBRIDGE CREAM



HOUGHTON GREY

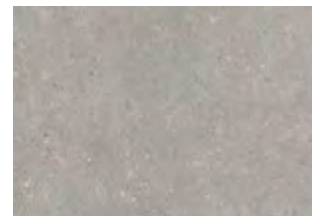

BRIDPORT GREY

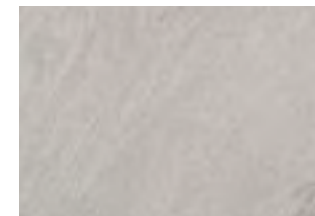

MOTTISFONT GREY

### Swimming Pool Copings:

with full bullnose 900 x 298 x 20mm  
 90° Square & 6" Radius Corners, 4ft & 5ft Roman Ends are made to order.  
 Cut to size and bespoke profile available.

# Porcelain Grip Finish 20mm Range

Suitable for Pool Surrounds and Landscape Projects

## 99 SERIES 900 x 900 x 20mm



WILTON BEIGE



SARUM GREY

### Swimming Pool Copings:

with full bullnose 900 x 450 x 20mm  
90° Square & 6" Radius Corners, 4ft & 5ft Roman Ends are made to order.  
*Cut to size and bespoke profile available.*

## 126 SERIES 1200 x 600 x 20mm

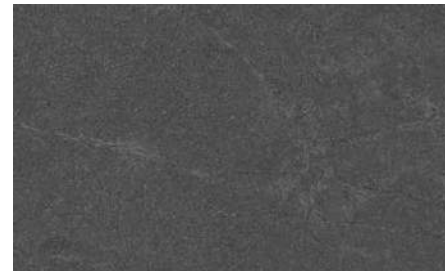

TICHBORNE



AVINGTON



CHERITON



EASTON

### Swimming Pool Copings:

with full bullnose 1200 x 298 x 20mm  
90° Square & 6" Radius Corners, 4ft & 5ft Roman Ends are made to order.  
*Cut to size and bespoke profile available.*

# Pool Lining Colour

As the trend for lining a pool now moves away from small mosaics and towards large format porcelain tiles, a question we are often asked is how to create a certain pool water colour. Obviously setting, lighting and weather play a large part in how pool water looks, however as a general rule of thumb, please follow our handy guide below:



For a bright blue / turquoise Mediterranean colour, we would recommend a white, cream or sandy coloured tile.



For a mid-blue colour, we would recommend a light grey / Pale Blue coloured tile.



For a Dark Blue pond like colour, we recommend a Dark Blue, Dark Green or Black coloured Tile.



# Pool Lining with large format Porcelain Tiles

Lining a swimming pool with Cranbourne 10mm large format Porcelain tiles has never been easier. Using our 'Template in a tube' we can supply the tiles and also cut the holes for the lights and skimmers with ease. Please see below how simple and effective the porcelain tiles are applied to the pool tank and how by leaving out the tile where the light or skimmer is, taping on our cut to size Template sheet and then posting back to us, we can cut the holes exactly to template and then deliver these to site for you. No more stress on site, just a precision cut and a pool with a perfect finish.



**Why not use our 'Template in a Tube' service ....**

*Buy the tiles to line your pool and we will cut the lights and skimmers free of charge!*

# Porcelain 10mm Range

For Pool Tanks and Walls

\* Grip Finish suitable for Indoor Pool Surrounds

## 63 SERIES 600 x 300 x 10mm



NAMUR LIGHT \*

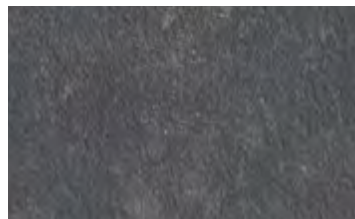

NAMUR DARK \*



PORTLAND CREAM



STUDLAND BEIGE



AVINGTON \*

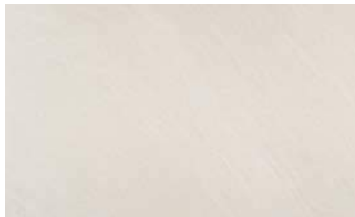

AWBRIDGE CREAM

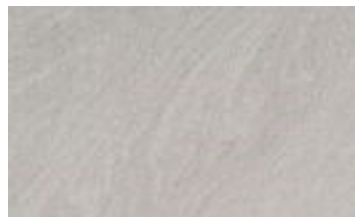

MOTTISFONT GREY



MEON QUARTZ \*



HOUGHTON GREY \*



WATERFORD CREAM \*



TICHBORNE \*



CHERITON \*



EASTON \*

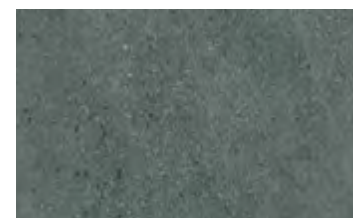

CAULFIELD GREEN \*



CORFE GREY

# Porcelain 10mm Range

For Pool Tanks and Walls

\* Grip Finish suitable for Indoor Pool Surrounds

## 66 SERIES

600 x 600 x 10mm



NAMUR LIGHT \*

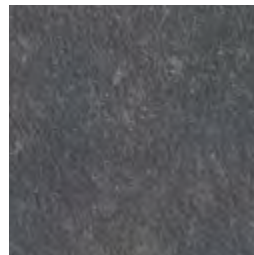

NAMUR DARK •

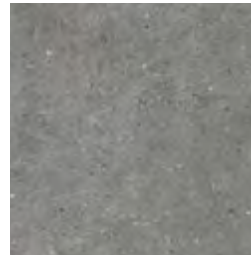

CORFE GREY \*

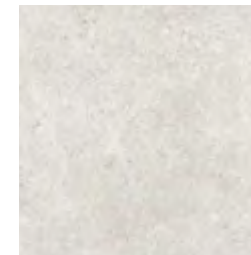

PORTLAND CREAM \*

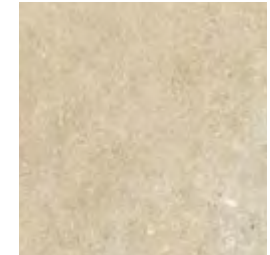

STUDLAND BEIGE \*



AWBRIDGE CREAM \*

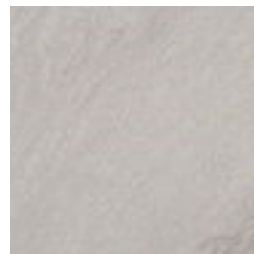

MOTTISFONT GREY \*

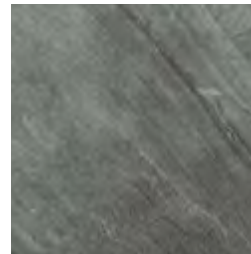

MEON QUARTZ \*



HOUGHTON GREY \*

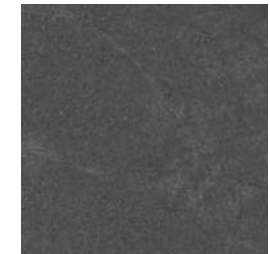

TICHBORNE \*

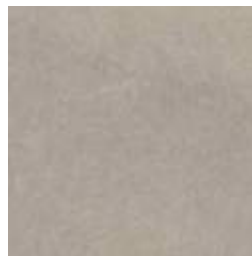

EASTON \*



CHERITON \*

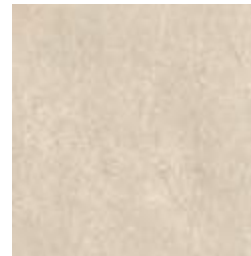

AVINGTON \*



BRIDPORT \*

# Porcelain 10mm Range

For Pool Tanks and Walls

\* Grip Finish suitable for Indoor Pool Surrounds

## 64 SERIES 600 x 400 x 10mm



WILTON BEIGE



SARUM GREY

## 945 SERIES 900 x 450 x 10mm



MEON QUARTZ



HOUGHTON GREY



CAULFIELD GREEN



WATERFORD CREAM

## 96 SERIES 900 x 600 x 10mm



BRIDPORT \*

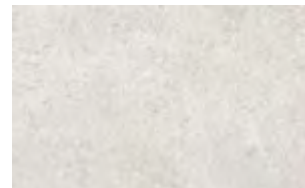

PORTLAND CREAM \*

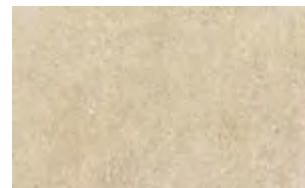

STUDLAND \*



CORFE GREY \*

## 75 SERIES 750 x 750 x 10mm



AWBRIDGE CREAM \*



MOTTISFONT \*

# Porcelain 10mm Range

For Pool Tanks and Walls

\* Grip Finish suitable for Indoor Pool Surrounds

## 126 SERIES

1200 x 600 x 10mm

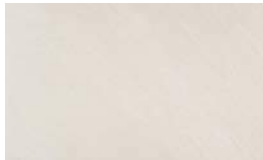

AWBRIDGE CREAM \*

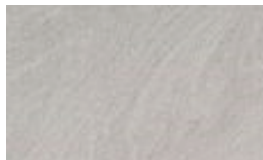

MOTTISFONT \*



NAMUR LIGHT \*



CHERITON



AVINGTON



NAMUR DARK \*



TICHBORNE



EASTON



MEON QUARTZ \*



CAULFIELD GREEN \*



HOUGHTON GREY \*



WATERFORD CREAM \*

## 99 SERIES

900 x 900 x 10mm

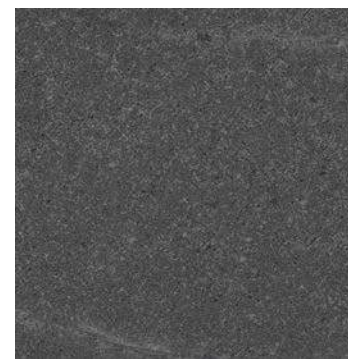

TICHBORNE



EASTON

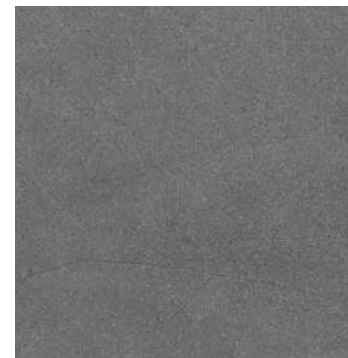

CHERITON

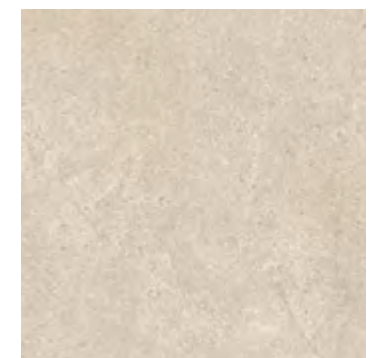

AVINGTON

# Natural Stone Finishes

Our natural stone range has been finely selected from countries world-wide and includes high quality Granite, Marble, Limestone, Travertine, Sandstone, and Basalt. All of which are available in various finishes and thicknesses. Part of the beauty of natural stone is its tonal variation and organic properties. Being such a versatile material we are able to apply many finishes to the stone to create the following finishes.

## Honed

A lightly polished surface using sand/water to remove any saw marks, resulting in a nice clean and smooth finish.

## Sandblasted

A shot-blast media is fired at high pressure onto the stone resulting in a lightly textured surface with an increased slip resistance.

## Riven / Natural Cleft

A natural rough surface of layered stone (sandstone/slate) with natural variations.

## Tumbled

Tumbled in machines filled with pebbles creating an appearance of a naturally time-aged worn surface.

## Antique

Partly honed and then tumbled to create that aged look with a slightly duller finish.

## Satin Contemporary

Honed and then sandblasted for a greater slip resistant finish. An acid wash is then applied to enhance the colour of the stone.

## Flamed

Using a mixture of heat and water, the stone is flamed to create a rugged textured surface - increasing slip resistance. Generally applied to Granite and Basalt.

## Sawn

Straight cut edge tiles, with light sawn markings.

## Tumbled Grip

Tumbled as above and then washed with acid to lightly etch the stone surface for a slip resistant finish.

# Swimming Pool Coping Options

Here are a selection of images to show the different coping styles.



Freeform bullnosed coping



Square Edge with pencil edge top & bottom



Porcelain Over-lip coping with automatic pool cover system



Full Bullnose with Automatic Cover channel



Full Bullnose with liner Lock

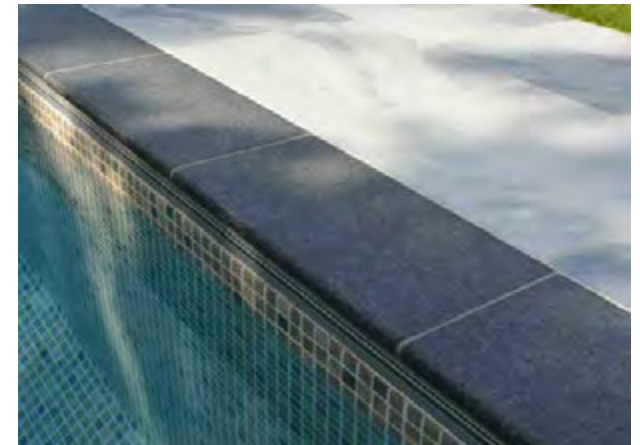

Bullnosed Coping in contrasting colour to define the edge.

# Cotswold Mint Sandstone

Our Cotswold Mint Riven Sandstone has been hand selected and calibrated to ensure only the best quality mint and light buff tones are chosen to create a wonderfully rustic and yet uplifting landscape.



## Paving:

600 Series Mixed Patio Pack.  
16.74m<sup>2</sup> coverage per pack.  
22mm thick - calibrated  
(See page 75 for laying pattern)

## Step Treads:

with full bullnose  
600 x 450 x 40mm

## Swimming Pool Copings:

with full bullnose  
600 x 225 x 40mm  
600 x 300 x 40mm  
90° Square & 6" Radius Corners,  
4ft & 5ft Roman Ends are made to order.

*Cut to size and bespoke profile available.*

## Bespoke:

Free-form shaped copings & bespoke stone work are made to measure in-house. Site template service available.



*Natural stone varies in both colour and texture. Sandstone in particular will not be consistent in colour. The appearance of the stone will change when wet, enhancing the natural tones within the stone.*

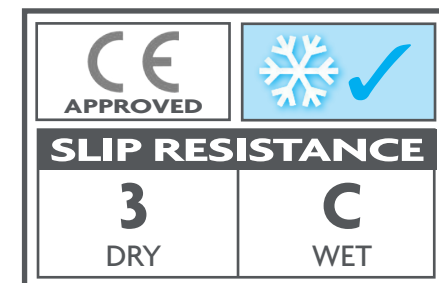





# Raj Riven Sandstone

This very popular riven sandstone contains subtle olive tones enhanced with a blend of warm browns and greys. It is the perfect, more affordable alternative to English York Stone. Ideal for any outdoor landscaping or swimming pool project.



## Paving:

600 Series Mixed Patio Pack.  
16.74m<sup>2</sup> coverage per pack.  
22mm thick - calibrated  
(See page 75 for laying pattern)

## Step Treads:

with full bullnose  
600 x 450 x 40mm

## Swimming Pool Copings:

with full bullnose  
600 x 300 x 40mm  
90° Square & 6" Radius Corners,  
4ft & 5ft Roman Ends are made to order.

*Cut to size and bespoke profile available.*

## Bespoke:

Free-form shaped copings & bespoke stone work are made to measure in-house. Site template service available.

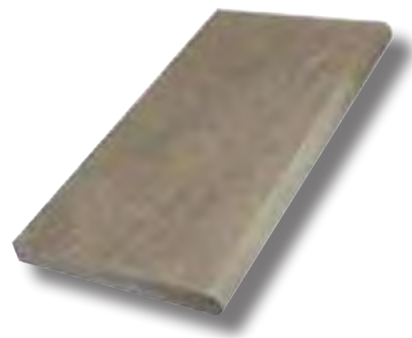

*Natural stone varies in both colour and texture. Sandstone in particular will not be consistent in colour. The appearance of the stone will change when wet, enhancing the natural tones within the stone.*



*Shown when wet*

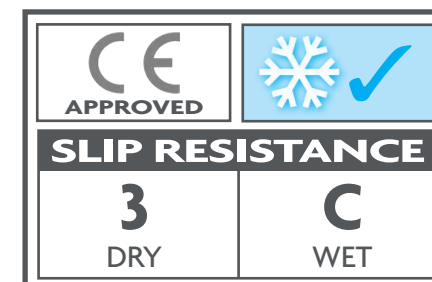



# Georgian Antiqued Sandstone

This natural riven grey sandstone has been tumbled to create an antique look, perfect for any pool surround and landscape project, with a traditional or vintage style.



## Paving:

600 Series Mixed Patio Pack.  
16.74m<sup>2</sup> coverage per pack  
Single size 900 x 600mm  
22mm thick - calibrated  
(See page 75 for laying pattern)

## Step Treads:

with full bullnose  
600 x 450 x 40mm

## Swimming Pool Copings:

with full bullnose  
600 x 300 x 40mm  
90° Square & 6" Radius Corners,  
4ft & 5ft Roman Ends are made to order.



*Cut to size and bespoke profile available.*

## Bespoke:

Free-form shaped copings & bespoke stone work are made to measure in-house. Site template service available.



*Natural stone varies in both colour and texture. Sandstone in particular will not be consistent in colour. The appearance of the stone will change when wet, enhancing the natural tones within the stone.*

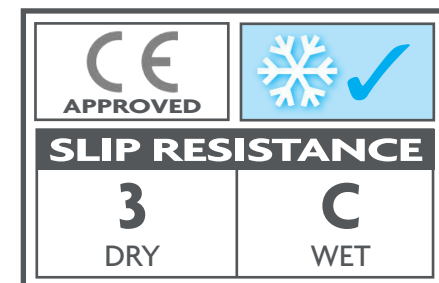



# Danebury Sandstone

This honed sandstone with a combination of mint and buff tones is ideal for any contemporary or traditional landscaping or swimming pool project.



## Paving:

Heritage Mixed Pack Paving.  
16.98m<sup>2</sup> coverage per pack.

Single size 900 x 600 x 22mm  
22mm thick - calibrated  
(See page 75 for laying pattern)

## Step Treads:

with full bullnose

600 x 450 x 40mm  
1200 x 350 x 40mm

## Swimming Pool Copings:

with full bullnose

600 x 300 x 40mm

90° Square & 6" Radius Corners,  
4ft & 5ft Roman Ends are made to order.

*Cut to size and bespoke profile available.*

## Bespoke:

Free-form shaped copings & bespoke stone work are made to measure in-house. Site template service available.



*Natural stone varies in both colour and texture. Sandstone in particular will not be consistent in colour. The appearance of the stone will change when wet, enhancing the natural tones within the stone.*

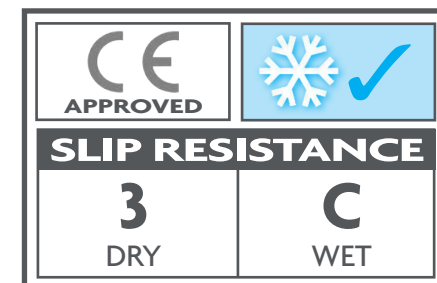



# Leckford Sandstone

A wonderfully elegant sandstone with buff tones and lightly sandblasted textured surface for slip resistance. It has the charm of a traditional English Yorkstone. A stylish choice for any landscape or swimming pool project.



## Paving:

900 x 600 x 30mm

*Other paving sizes available on request.*

## Step Treads:

with full bullnose

600 x 450 x 40mm



## Swimming Pool Copings:

with full bullnose

600 x 300 x 40mm

90° Square & 6" Radius Corners,  
4ft & 5ft Roman Ends are made to order.



*Cut to size and bespoke profile available.*



## Bespoke:

Free-form shaped copings & bespoke stone work are made to measure in-house. Site template service available.

*Natural stone varies in both colour and texture. Sandstone in particular will not be consistent in colour. The appearance of the stone will change when wet, enhancing the natural tones within the stone.*

	
<b>SLIP RESISTANCE</b>	
<b>3</b> DRY	<b>C</b> WET





# York Stone

Our York Stone direct from the Yorkshire quarries is of the highest quality. Available in both Sawn & Natural Riven finish, this is without doubt one of the most classic natural stones from the UK.



## Paving:

Set widths of 400 / 500 / 600  
x Random Lengths x 50 - 75mm thick  
with Riven Finish

Set widths of 600 x Random Length  
x 50mm thick  
with Sawn Finish

## Step Treads:

with full bullnose - Sawn only  
600 x 450 x 50mm

## Swimming Pool Copings:

with full bullnose - Sawn only  
600 x 300 x 50mm  
90° Square & 6" Radius Corners,  
4ft & 5ft Roman Ends are made to order.

*Cut to size and bespoke profile available.*

## Bespoke:

Free-form shaped copings & bespoke stone work are made to measure in-house. Site template service available.



*Sawn York Stone*



*Natural stone varies in both colour and texture. Sandstone in particular will not be consistent in colour. The appearance of the stone will change when wet, enhancing the natural tones within the stone.*

	
<b>SLIP RESISTANCE</b>	
<b>3</b> DRY	<b>C</b> WET



*Riven York - Shown when wet*

# Travertine Tumbled & Unfilled

Our light cream/honey-toned Tumbled & Unfilled Travertine is full of natural character and texture, creating a wonderful rustic look to any indoor or outdoor project.

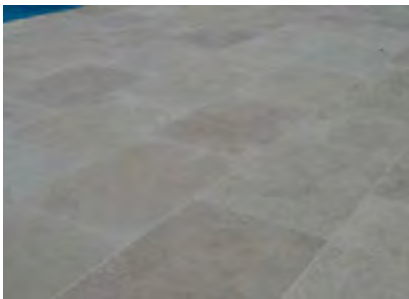

## Tiles:

610 x 406 x 12mm  
Opus (mixed pattern) x 12mm  
*Other sizes available on request.*

## Paving:

610 x 406 x 30mm  
*Other sizes available on request.*

## Steps:

with full bullnose  
610 x 406 x 30mm

## Swimming Pool Copings:

with full bullnose  
610 x 305 x 30mm  
90° Square & 6" Radius Corners,  
4ft & 5ft Roman Ends are made to order.  
*Cut to size and bespoke profile available.*



## Bespoke:

Free-form shaped copings & bespoke stone work are made to measure in-house. Site template service available.

*Natural stone varies in both colour and texture. The appearance of the stone will change when wet, enhancing the natural tones within the stone.*

CE APPROVED	
<b>SLIP RESISTANCE</b>	
<b>3</b> DRY	<b>C</b> WET



**NEW**

# Fossil Pearl Limestone - Tumbled + Grip

This very dense limestone with its beige/grey tones and wonderful fossil markings, has been tumbled and etched to create an elegantly aged and slip resistant stone, perfect for any swimming pool or landscaping project.



## Tiles:

600 x 400 x 20mm

900 x 600 x 20mm

*Other tile sizes available on request.*

## Paving:

900 x 600 x 30mm

## Step Treads:

with full bullnose

600 x 450 x 40mm

## Swimming Pool Copings:

600 x 400 x 20mm

with pencil edge

600 x 300 x 40mm

with full bullnose

90° Square & 6" Radius Corners,

4ft & 5ft Roman Ends are made to order.

*Cut to size and bespoke profile available.*

## Bespoke:

Free-form shaped copings & bespoke stone work are made to measure in-house. Site template service available.



*Natural stone varies in both colour and texture. The appearance of the stone will change when wet, enhancing the natural tones within the stone.*

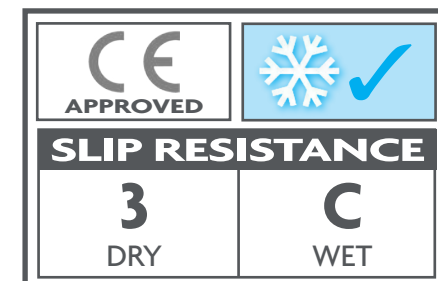



# Fossil Pearl Limestone - Satin

A dense fossil limestone with warm beige and grey tones with a sandblasted finish and sawn edges giving a wonderful contemporary look. Ideal for indoor and outdoor projects.



## Tiles:

900 x 600 x 20mm  
*Other tile sizes available on request.*

## Paving:

900 x 600 x 30mm

## Step Treads:

with full bullnose  
600 x 450 x 40mm

## Swimming Pool Copings:

600 x 400 x 20mm  
with pencil edge  
600 x 300 x 40mm  
with full bullnose  
90° Square & 6" Radius Corners,  
4ft & 5ft Roman Ends are made to order.

*Cut to size and bespoke profile available.*

## Bespoke:

Free-form shaped copings & bespoke stone work are made to measure in-house. Site template service available.



*Natural stone varies in both colour and texture. The appearance of the stone will change when wet, enhancing the natural tones within the stone.*

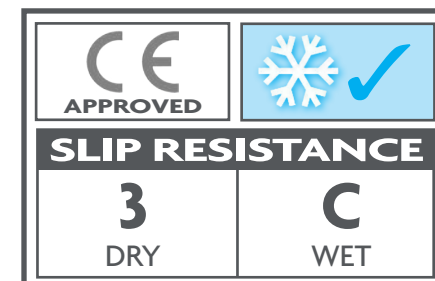





# Crema Europa Limestone

This wonderful Limestone with its cream/beige tones and stunning waves of sweeping beige markings is a truly stylish Limestone for both indoor and outdoor projects. Available in Honed and Sandblasted finishes. The sandblasted finish is a perfect slip resistant stone for an elegant pool surround.

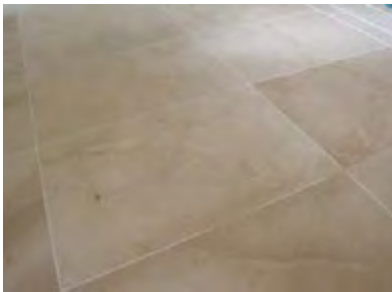

## Tiles:

600 x 400 x 20mm  
600 x 600 x 20mm  
*Other sizes available to order.*

## Paving:

600 x 600 x 30mm  
*Other sizes available to order.*

## Step Treads:

with full bullnose  
600 x 450 x 40mm

## Swimming Pool Copings:

600 x 400 x 20mm  
with pencil edge  
600 x 300 x 40mm  
with full bullnose  
90° Square & 6" Radius Corners,  
4ft & 5ft Roman Ends are made to order.

*Cut to size and bespoke profile available.*

## Bespoke:

Free-form shaped copings & bespoke stone work are made to measure in-house. Site template service available.

*Natural stone varies in both colour and texture. The appearance of the stone will change when wet, enhancing the natural tones within the stone.*

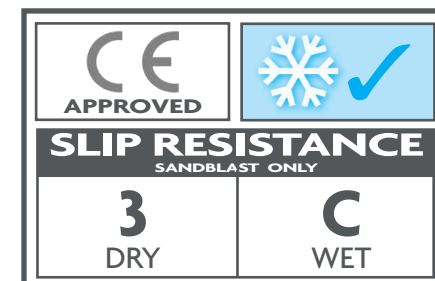



# Broughton Limestone

This very dense Limestone with its blue/grey sandblasted finish is a truly stylish Limestone for modern indoor and outdoor projects.



## Paving / Tiles:

600 x 600 x 25mm

## Step Treads:

1000 x 300 x 50mm  
with square edge

1000 x 300 x 50mm  
with full bullnose

## Swimming Pool Copings:

600 x 300 x 25mm  
with full bullnose

1000 x 300 x 50mm  
with full bullnose

1000 x 300 x 50mm  
with square edge

90° Square & 6" Radius Corners,  
4ft & 5ft Roman Ends are made to order.

*Cut to size and bespoke profile available.*

## Bespoke:

Free-form shaped copings & bespoke stone work are made to measure in-house. Site template service available.

*Natural stone varies in both colour and texture. The appearance of the stone will change when wet, enhancing the natural tones within the stone.*



*Stone shown wet*

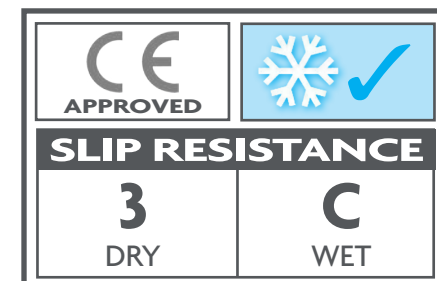



# Downton Limestone

This olive/grey and buff tone stone is gently undulated and has been tumbled and part honed for a wonderfully understated and rustic traditional look. This can be used for both indoor and outdoor projects.



## Paving / Tiles:

560 x random length  
(420, 560, 700 & 840mm)  
Thickness 22mm calibrated  
900 x 600 x 22mm

## Step Treads:

with full bullnose  
600 x 450 x 40mm

## Swimming Pool Copings:

with full bullnose  
600 x 300 x 40mm

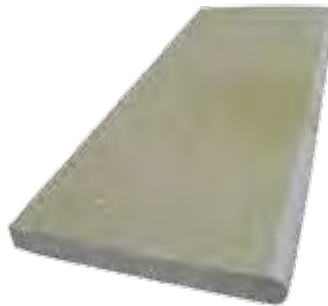

90° Square & 6" Radius Corners,  
4ft & 5ft Roman Ends are made to order.

*Cut to size and bespoke profile available.*

## Bespoke:

Free-form shaped copings & bespoke stone work are made to measure in-house. Site template service available.



*Natural stone varies in both colour and texture. The appearance of the stone will change when wet, enhancing the natural tones within the stone.*

<b>CE</b> APPROVED	
<b>SLIP RESISTANCE</b>	
<b>3</b> DRY	<b>C</b> WET



# Pembury Marble

This beautiful white/grey marble with its sawn edges and soft sandblasted textured surface is both stylish and modern. Perfect for any indoor or outdoor project.



## Tiles:

600 x 600 x 15mm

## Paving:

600 x 600 x 30mm

## Swimming Pool Copings:

600 x 298 x 15mm  
with pencil edge

600 x 300 x 30mm  
with full bullnose

600 x 300 x 30/50mm  
with over-lip

90° Square & 6" Radius Corners,  
4ft & 5ft Roman Ends are made to order.

*Cut to size and bespoke profile available.*

## Bespoke:

Free-form shaped copings & bespoke stone work are made to measure in-house. Site template service available.

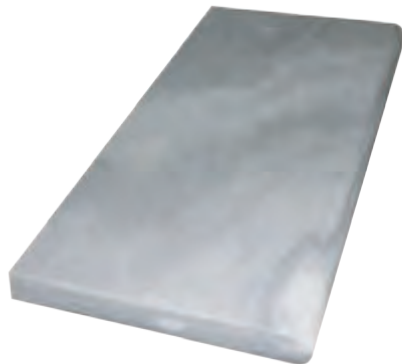

*Natural stone varies in both colour and texture. The appearance of the stone will change when wet, enhancing the natural tones within the stone.*

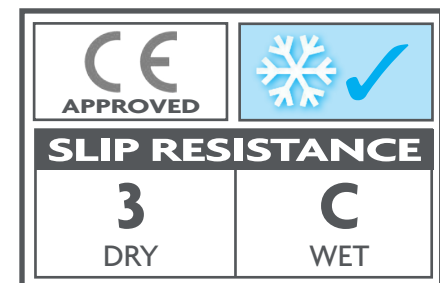





# Fullerton Grey Granite

This flamed Grey Granite with its straight sawn edges is a wonderful slip resistant option for both indoor and outdoor modern projects.



## Paving:

600 x 400 x 30mm

600 x 600 x 30mm

600 x 400 x 20mm

600 x 600 x 20mm

*Other tiles sizes available on request.*

## Step Treads:

with full bullnosed edge (flamed)

600 x 400 x 30mm

## Swimming Pool Copings:

600 x 300 x 30mm

with full bullnosed edge (flamed)

600 x 300 x 30/50mm

with an over-lip (polished)

90° Square & 6" Radius Corners,  
4ft & 5ft Roman Ends are made to order.



*Cut to size and bespoke profile available.*

## Bespoke:

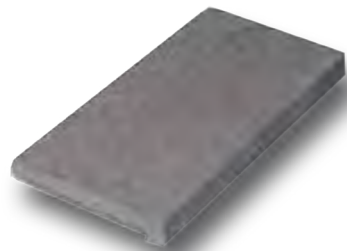
Free-form shaped copings & bespoke stone work are made to measure in-house. Site template service available.



*Natural stone varies in both colour and texture. The appearance of the stone will change when wet, enhancing the natural tones within the stone.*

	
<b>SLIP RESISTANCE</b>	
<b>3</b> DRY	<b>C</b> WET

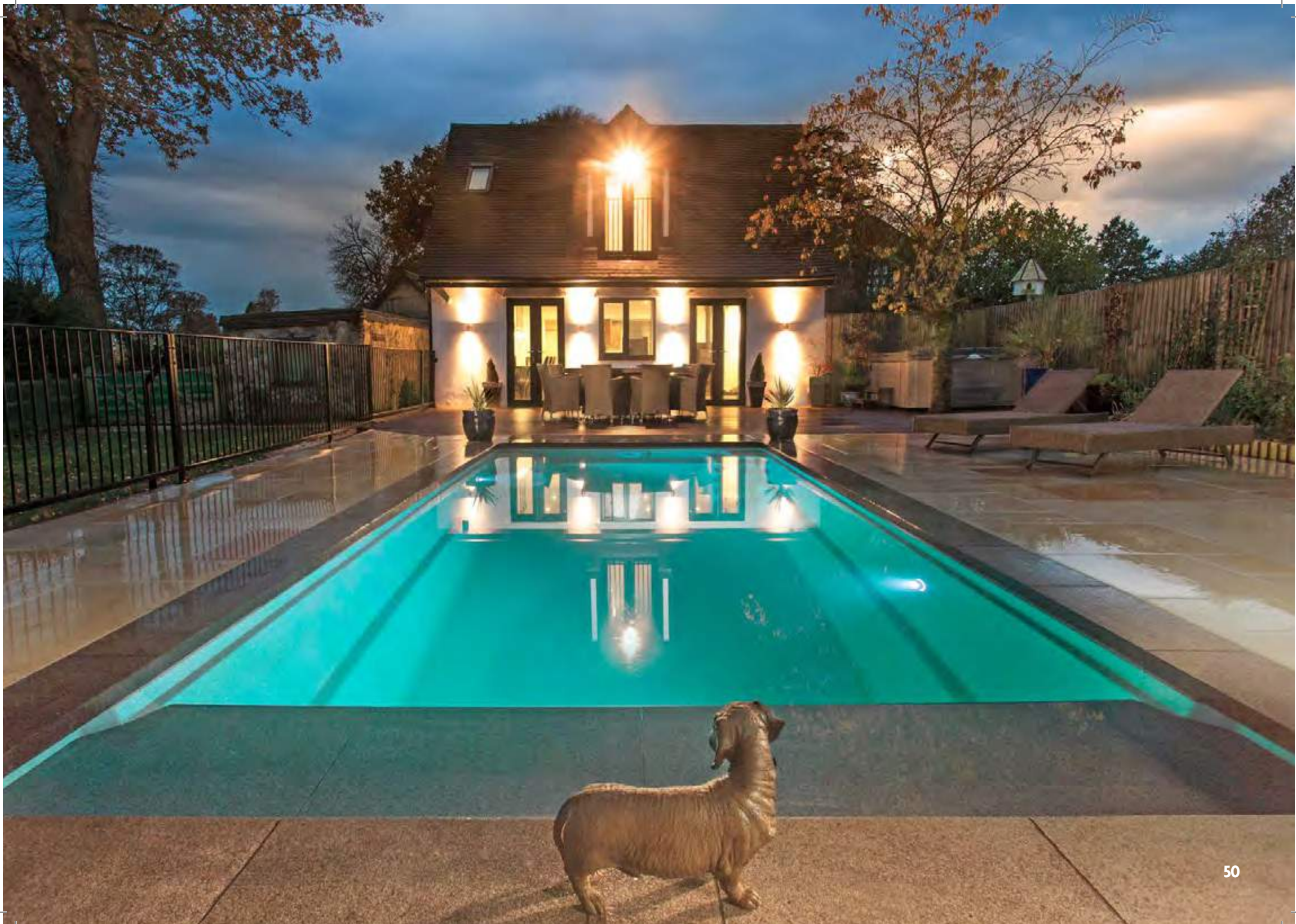

# Montreal Granite

Our Montreal Grey Granite is flamed and brushed for a slip resistant finish. Its natural white veining sparkles in the sunlight. This stone is perfect for any modern and unique pool surround or landscaping project.

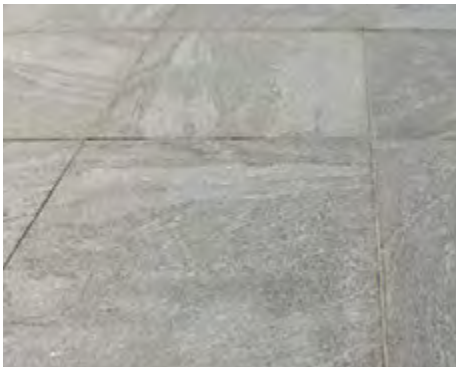

### Tiles:

600 x 600 x 20mm

### Paving:

600 x 600 x 30mm

### Swimming Pool Copings:

600 x 300 x 30mm  
with full bullnose

600 x 300 x 30/50mm  
with an over-lip

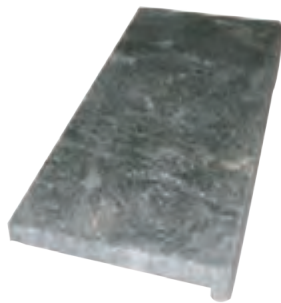

90° Square & 6" Radius Corners,  
4ft & 5ft Roman Ends are made to order.

*Cut to size and bespoke profile available.*

### Bespoke:

Free-form shaped copings & bespoke stone work are made to measure in-house. Site template service available.



*Natural stone varies in both colour and texture. The appearance of the stone will change when wet, enhancing the natural tones within the stone.*

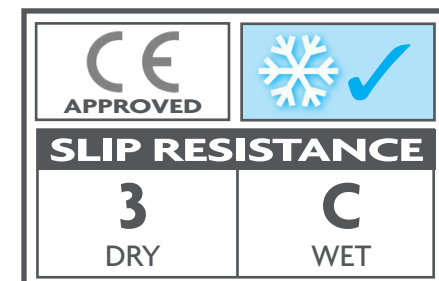



# Chattis Black Basalt

This stunning black basalt with its flamed finish is the ideal stone for modern swimming pool surrounds and terraces.

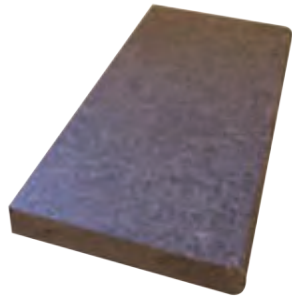

**Tiles:**

600 x 600 x 20mm

**Paving:**

600 x 400 x 30mm

600 x 600 x 30mm

**Steps:**

with full bullnose (flamed)

600 x 400 x 30mm

**Swimming Pool Copings:**

600 x 300 x 30mm

with full bullnosed edge (flamed)

600 x 300 x 30/50mm

with an over-lip (polished)



90° Square & 6" Radius Corners,  
4ft & 5ft Roman Ends are made to order.

*Cut to size and bespoke profile available.*

**Bespoke:**

Free-form shaped copings & bespoke stone work are made to measure in-house. Site template service available.



*Natural stone varies in both colour and texture. The appearance of the stone will change when wet, enhancing the natural tones within the stone.*

<b>SLIP RESISTANCE</b>	
<b>3</b> DRY	<b>C</b> WET



# Edge Profiles & Swimming Pool Copings

Using our extensive experience and knowledge in swimming pool installation, we have supplied swimming pool copings and surrounds nationwide for nearly 14 years. Working with architects, designers and pool installers over this time has allowed us to utilise our vast knowledge to enable our customers to bring their complex projects through to fruition, therefore broadening our prodigious portfolio. Our range of pool surrounds is ever expanding and our materials are selected specifically for this purpose. We have standard stock size pool copings, corners and roman end kits, in both natural stone and porcelain. Our bespoke service is available for more complex projects. Please see below details of the standard components :-

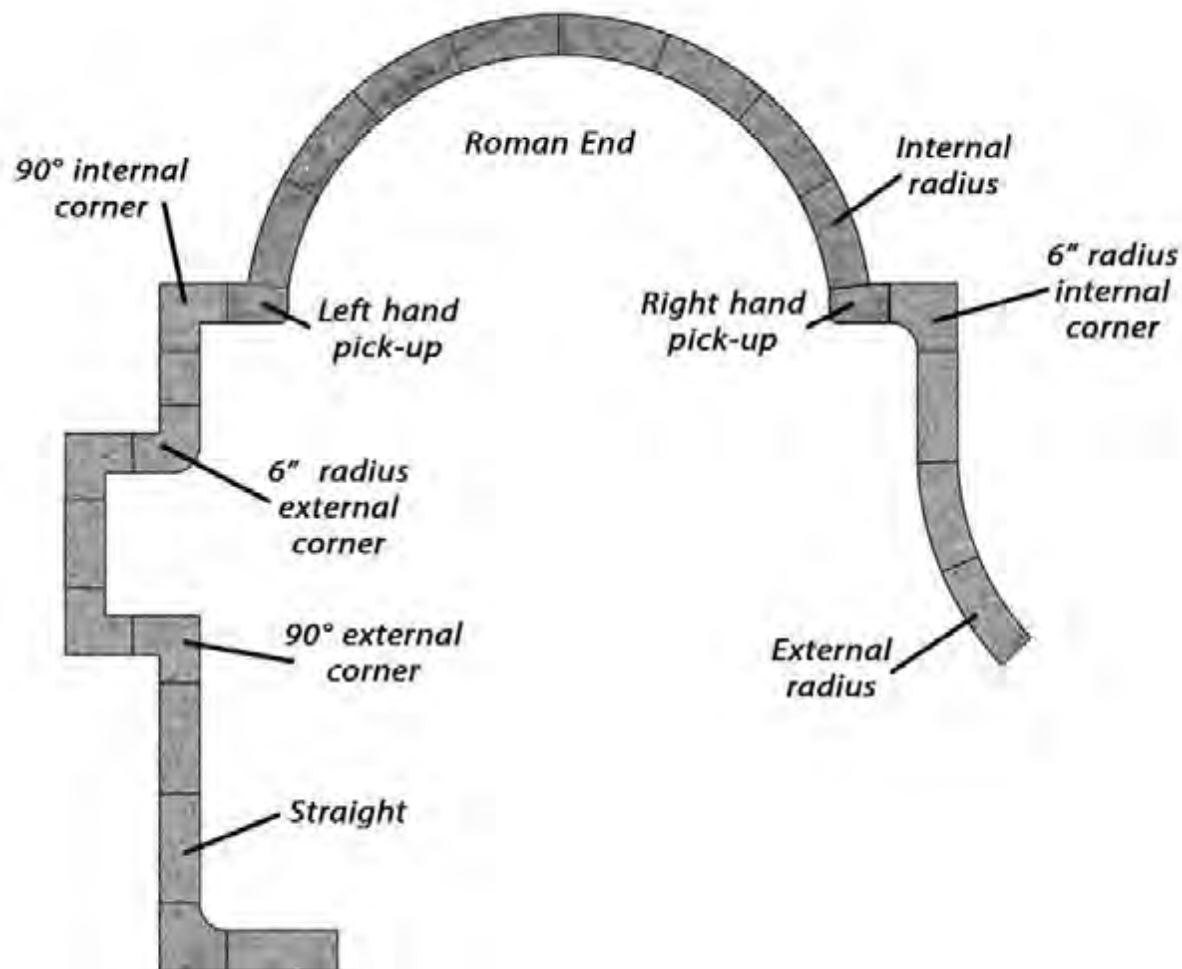

Full Bullnose



Half Bullnose



Arris Off

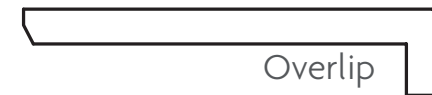

Overlip

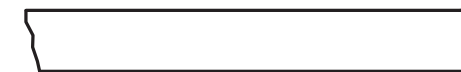

Pencil Top Only



Pencil Top & Bottom



# Roman End Bays and Corners

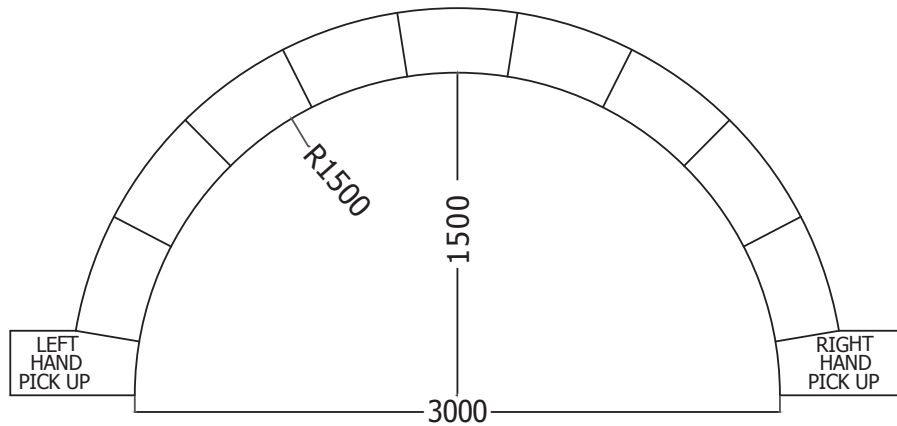

**5FT ROMAN END BAY**

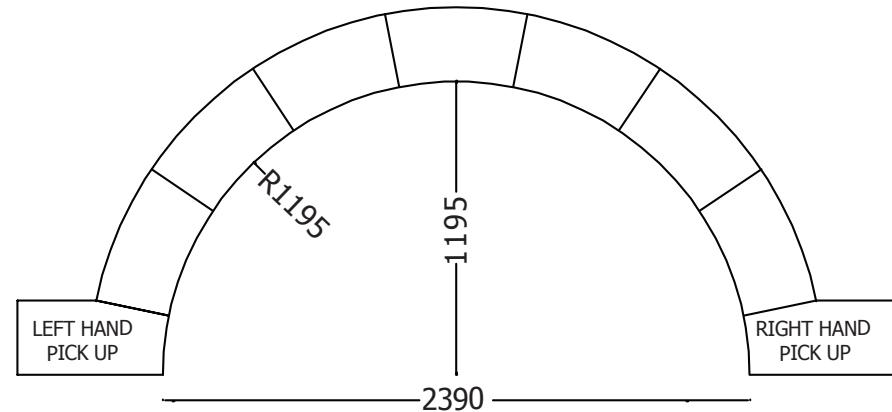

**4FT ROMAN END BAY**  
*(Country leisure 10ft roman end bay)*

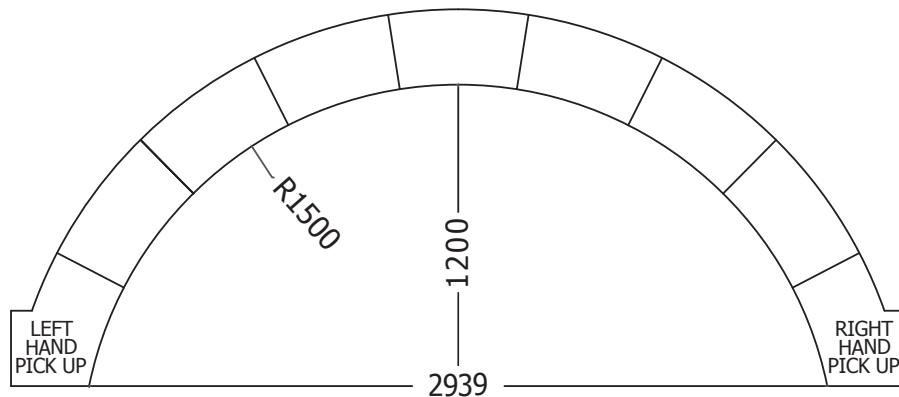

**5FT LOW PROFILE ROMAN END BAY**  
*(Country leisure 12ft roman end bay)*

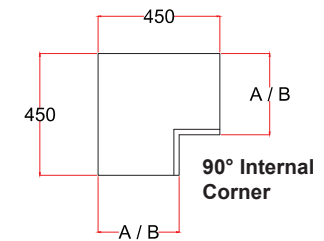
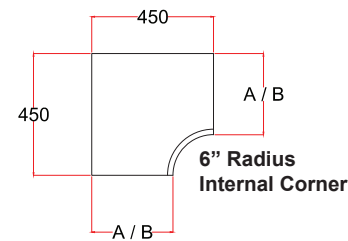

A = 298 (Porcelain)  
B = 300 (Natural Stone)

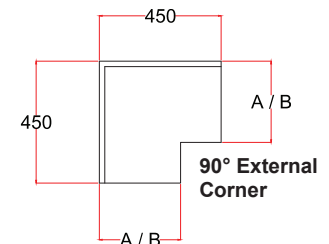
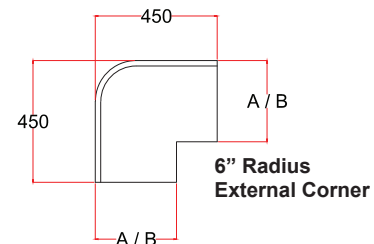

# Contemporary Deck Level Grilles

Our Contemporary Deck Level Grille is made in house using precision Waterjet machinery to cut the slots to SPATA standards. Using our CNC machinery the grilles can be rebated to fit perfectly into our coping and backing stone to create a 3 piece module system or alternatively for refurbishment projects, where you may be replacing a plastic or Aluminium Grille, we can produce this is a 20mm thick Lapitec® sintered stone, which can sit into the existing structure.

The contemporary Grille is suitable for residential use and can be used in both indoor and external projects in most of our Natural Stone range and Lapitec® sintered stone.

Matching Tiles and Paving are available and as standard practice in the pool surrounding tile (on a Deck Level Pool) should always be laid with a 1:40 fall towards the pool, to allow any escaped water to flow back into the channel. For pools with swim jets and high volume of swimmers we would recommend the Dished Deck Level Grille.

Every set commissioned is made to our client's requirements. Taking advantage of our Swimming Pool installation knowledge we can discuss best options available to suit your project.





# Dished Deck Level Grilles

Our Dished Deck Level Grille is made in house using precision Waterjet machinery to cut the slots to SPATA standards. Using our CNC machinery the grilles can be rebated to fit perfectly into our coping and backing stone to create a 3 piece module system or alternatively for refurbishment projects, where you may be replacing a plastic or Aluminium Grille, we can produce this in a 30mm thick Lapitec® sintered stone, which can sit into the existing structure.

The Dished Grille is suitable for residential and Semi-commercial use and can be used in both indoor and external projects in most of our Natural Stone range and Lapitec® sintered stone.

Matching Tiles and Paving are available and as standard practice in the pool surrounding tile (on a Deck Level Pool) should always be laid with a 1:40 fall towards the pool, to allow any escaped water to flow back into the channel.

Every set commissioned is made to our client's requirements. Taking advantage of our Swimming Pool installation knowledge we can discuss best options available to suit your project.





## 2x Linear Slot Grilles

Our 2 x Linear Slot Deck Level Grille is made in house using precision Waterjet, CNC and profiling machinery. The popularity of this grille is due to the fact that the mechanics are on the underside of the grille, therefore almost disguising the grille and therefore creating a sleek contemporary look.

The grille can be rebated to fit perfectly into our coping and backing stone to create a 3 piece module system or alternatively for refurbishment projects, where you may be replacing a plastic or Aluminium Grille, we can produce this in 20mm thick Lapitec® sintered stone or our bonded 20mm slip resistant Porcelain which can sit into the existing structure.

The 2 x Linear Slot Grille is suitable for residential use and can be used in both indoor and external projects in most of our Natural Stone range, Lapitec® sintered stone and Slip Resistant Porcelain.

Matching Tiles and Paving are available and as standard practice in the pool surrounding tile (on a Deck Level Pool) should always be laid with a 1:40 fall towards the pool, to allow any escaped water to flow back into the channel.

Every set commissioned is made to our client's requirements. Taking advantage of our Swimming Pool installation knowledge we can discuss best options available to suit your project.





The Lapitec logo is written in a stylized, cursive font.The Lapitec logo is displayed in a bold, sans-serif font with the tagline 'Prestigious Italian Surface' underneath.

***Cranbourne Stone Ltd have developed a new range of deck level grilles, providing style and elegance with superior mechanical and physical properties.***

Utilising our vast experience as the leading provider of natural swimming pool copings and grilles, we have now extended our range to include three of our most popular deck level grilles manufactured from **Lapitec<sup>®</sup>** - a full bodied and almost indestructible sintered stone. Pool builders and architects will benefit from the knowledge of a bullet proof **'fit for purpose'** material, that offers a high level of anti-slip, and chemical resistance.

### ***Modular Support System***

Installing our new grilles has never been easier with our new Modular Support System. The system allows 20mm **Lapitec<sup>®</sup>** grilles to be laid perfectly over the drainage gully. *Key benefits:*

- **Precise and uniform laying**
- **Reduces install time**









## Perfect for Paving & Pool Cladding

A truly versatile material:

- **7 Different finishes**
- **10 Year product guarantee**
- **15 Colours to choose from**

Impervious to the outside elements:







- **Fade resistant**
- **Non porous**
- **Self cleaning**

	scratch resistant	EN14617-4
	water absorption	0.1%
	anti-bacterial	Biocare
	slab sizes	3365 x 1500mm
	thickness	12, 20, 30mm
	heat resistant	A1
	impact resistant	2.9 joule

## Cut to Size Service

As an approved fabricator, Cranbourne Stone are able to cut **Lapitec®** to size utilising our 5-axis waterjet and CNC machinery. Our expert stone masons are able to apply different edging profiles from bullnosed steps to bonded overlap.

- **Large format slabs available**
- **Paving/tiles supplied in 12, 20 and 30mm**
- **Up to R13 slip rating**

	flexural strength	53N/mm <sup>2</sup>
	frost resistant	yes
	coefficient of linear thermal expansion	6.3 x 10 <sup>-6</sup> °C <sup>-1</sup>
	resistant to acid & alkali	C4
	thermal conductivity	1.3 W/m °K
	resistant to compression	230-250 N/mm <sup>2</sup>
	fade resistant	yes

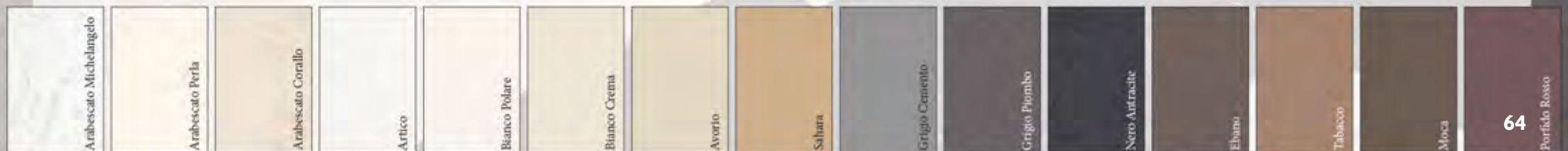

# Gallery

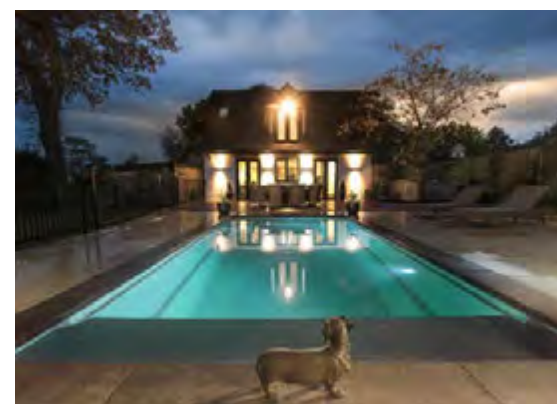
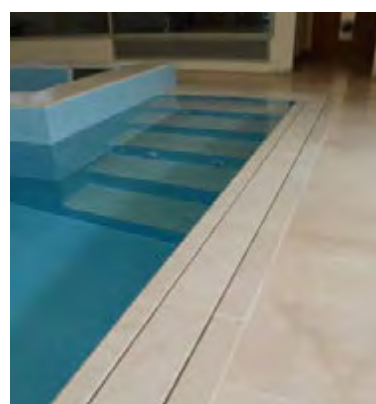
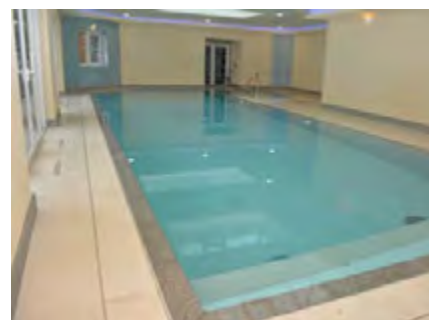
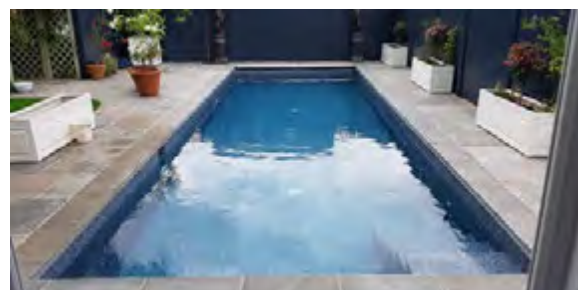
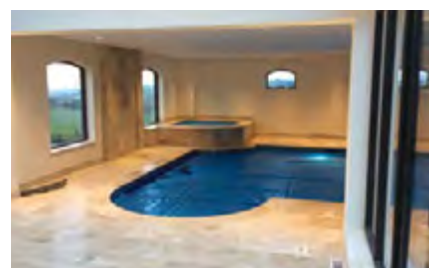
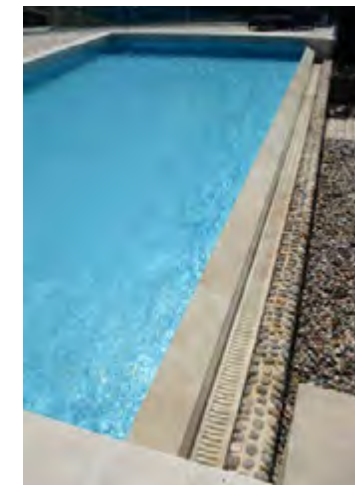
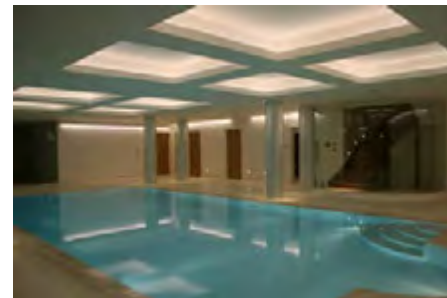

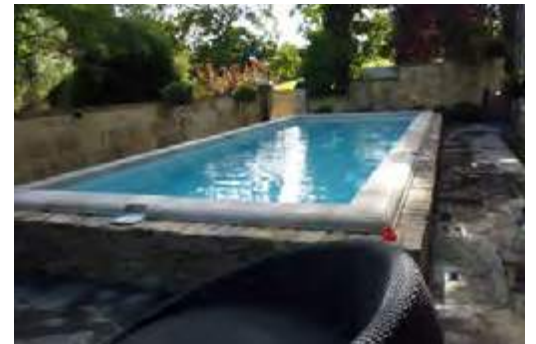

# Site Template / Survey

Taking the responsibility away from the builder by sending our surveyor to site with our digital templating device, takes a huge weight from busy shoulders. By using our laser to digitally measure any freeform/obscure shaped pool/landscape area, we can create a CAD drawing and cutting schedule, which can be loaded straight into the machinery in our yard, ready to start precision cutting.

Benefitting from our CNC waterjet, 5 axis saw and profiling machinery we are able to produce bespoke work easily, efficiently and speedily.

Give us a call to discuss your next project. We have the materials, technology and experience to make your designs achievable!

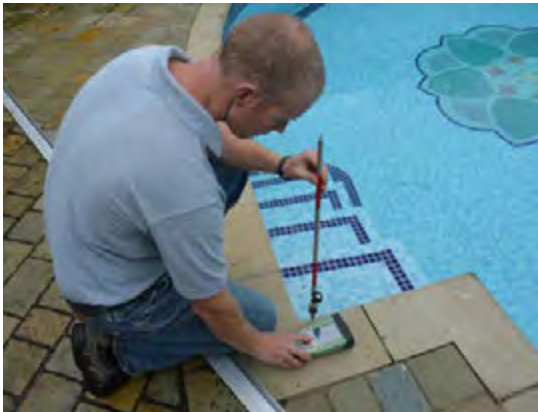

# Our In-House Bespoke Works

Our in-house CNC 5-Axis Bridge Saw, Waterjet and profiling machinery allows us to cut and shape stone without limitations. Working from CAD Drawings and templates we are able to upload drawings and create outstanding pieces of bespoke stone products.



# Bespoke Masonry

Having invested heavily in hi-tech computerised machinery, we are able to produce unique and individual stone and porcelain products for any pool or landscaping project.

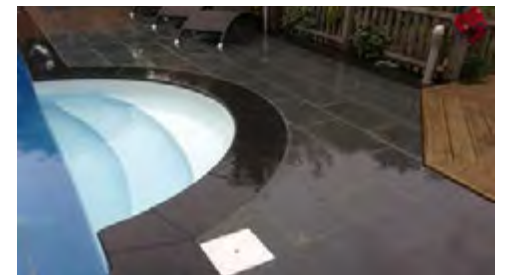
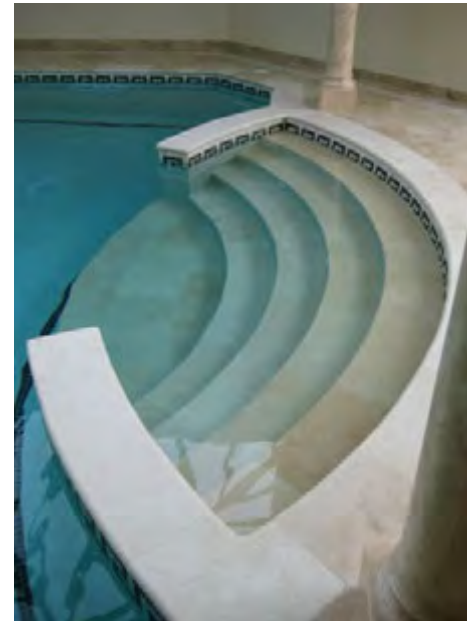

# Landscapers and Designers

Although initially our market was predominantly swimming pool surrounds, we are very pleased to be working with landscapers, designers and general builders supplying a wonderful range of natural stone and 20mm thick porcelain paving for landscapes nationwide. Utilising our investment in hi-tech machinery we are able to help create wonderful bespoke landscaping products, including radius step treads and risers, pier caps, wall capping and much more.



# Laying Guidelines for Natural Stone

In this section we are outlining the principle considerations for laying natural paving. However each project will have its own individual considerations and the advice of a professional should always be sought.

## Preparation

Decide where the paving is to be laid and mark or peg out clearly. Dig out a little wider than the planned project width allowing an extra 50mm - 75mm at the edges to make handling much easier. Bear in mind that any paving surfaces should be at least 150mm below any damp proof course and should have a 1:60 fall away from the building for surface drainage. Remember to remove all weeds and other unwanted organic matter.

## Sub-Base

The depth of the dig and the necessity for a sub-base will depend on the intended use and ground conditions. If a sub-base is required the depth should be approximately 190mm minimum. This will allow for:

- 100mm compacted hardcore or crushed stone with extra care being taken to ensure any soft spots are identified, dug out and filled.
- 25mm - 40mm slab depth
- 50mm bed

If a sub-base is not required, dig to 90mm. If elevating to a higher level then the elevation should be constructed by adding to the sub-base layer not by increasing the thickness of the bedding layer. Driveways will always require a sub-base made up of 100mm 'MOT' Type 1 hardcore so the dig will always be 190mm minimum.

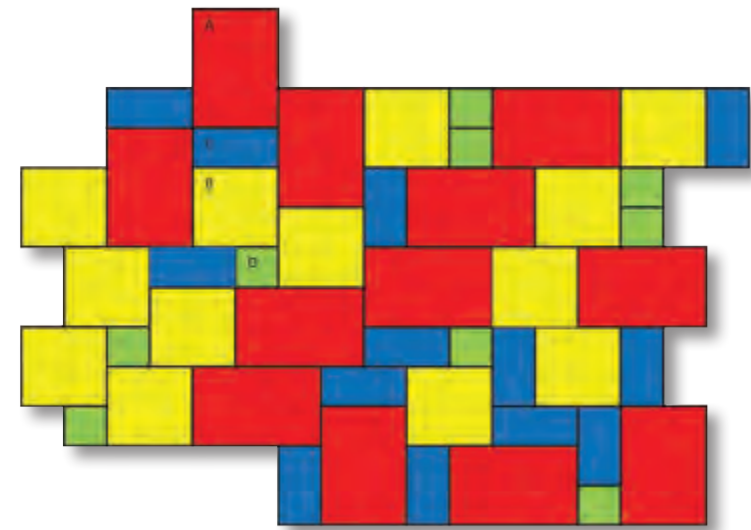



## Bedding

Depending on preference, the paving may be bedded onto either a full concrete bed (136 or St1 mix), or alternatively a 50mm (compacted depth) bed of sand, gravel and cement (6 parts 5mm - 6mm gravel, 4 parts sharp sand NOT BUILDING SAND and 1 part ordinary Portland-cement) - which should be spread to the area and compacted with a couple of passes of a plate compacter prior to bed preparation. The top 15mm - 25mm of the bed should be loosened / rippled to ease levelling as the natural slabs vary in depth. We would also recommend applying an SBR bonding agent to the underside of the lighter coloured sandstone and limestones, to eliminate any moisture patches appearing on the face of the stone.

## Laying

Natural stone products have variation in colour so select paving from a number of open packs to ensure an even blend. Where possible start with full flags being laid adjacent to a fixed point such as building or edging. Set the required level using a taut line. Tap each slab down to the appropriate level using a rubber mallet and also use a spirit level to double check levels with the adjacent slabs. It can be helpful to 'butter' the edges of previous slabs - being careful to maintain 10mm - 15mm between the slabs. To butter the previous slabs - trowel mortar onto their edges so that when the next slab is offered up, the mortar compresses and rises up between the slabs to form a joint that can be easily pointed.

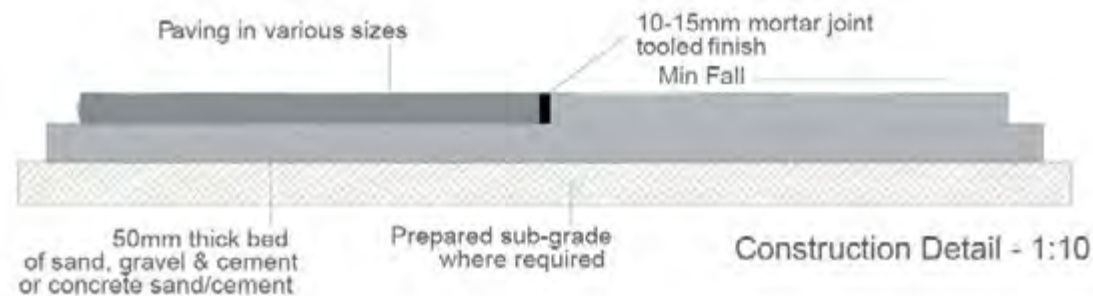

## Efflorescence

Efflorescence is a natural phenomenon and can occur in all natural paving products. It shows as white patches on the surface of the slabs. The efflorescence may occur each time the paving dries after rain. This may re-occur for up to 18 to 24 months. Efflorescence will cease as the calcium carbonate completely leaves the stone.

# Laying Guidelines for Porcelain

## Preparation for External Areas:

Decide where the paving is to be laid and mark or peg out clearly. Dig out a little wider than the planned project width, allowing an extra 50mm-75mm at the edges to make handling much easier. Bear in mind that any paving surfaces should be at least 150mm below any damp proof course and should have a 1:60 fall away from the building for surface drainage. Remember to remove all weeds and other unwanted organic matter.



## Sub-base

The depth of the dig and the necessity for a sub-base will depend on the intended use and ground conditions. If a sub-base is required the depth should be approximately 170mm minimum. This will allow for:

- 100mm compacted hardcore or crushed stone with extra care being taken to ensure any soft spots are identified, dugout and filled.
- 50mm slab depth
- 20mm bed

## 20mm Porcelain: Bedding

Carefully place the tiles onto a levelled out bed of standard sand/cement, mortar prepared to a wet consistency (slump of 50mm or more) the mortar bed needs to be a 6:1 or stronger mix of grit sand with ordinary Portland cement (OPC). We would recommend 30-50mm of the bedding mortar to be laid over the prepared sub-base and then spreading an SBR bonding agent to the underside of the porcelain tile to aid adhesion.

## 20mm Porcelain: Laying

Where possible start with full slabs being laid adjacent to a fixed point such as building or edging. Set the required level using a taut line. Tap each slab down to the appropriate level using a rubber mallet and also use a spirit level to double check levels with the adjacent slabs, being careful to maintain 4-5mm joints between the slabs. We would recommend using an external grade tiling grout in-between the joints. Ensure the grout residue is washed off completely (refer to grout manufacturer's recommendations for correct installation procedures).

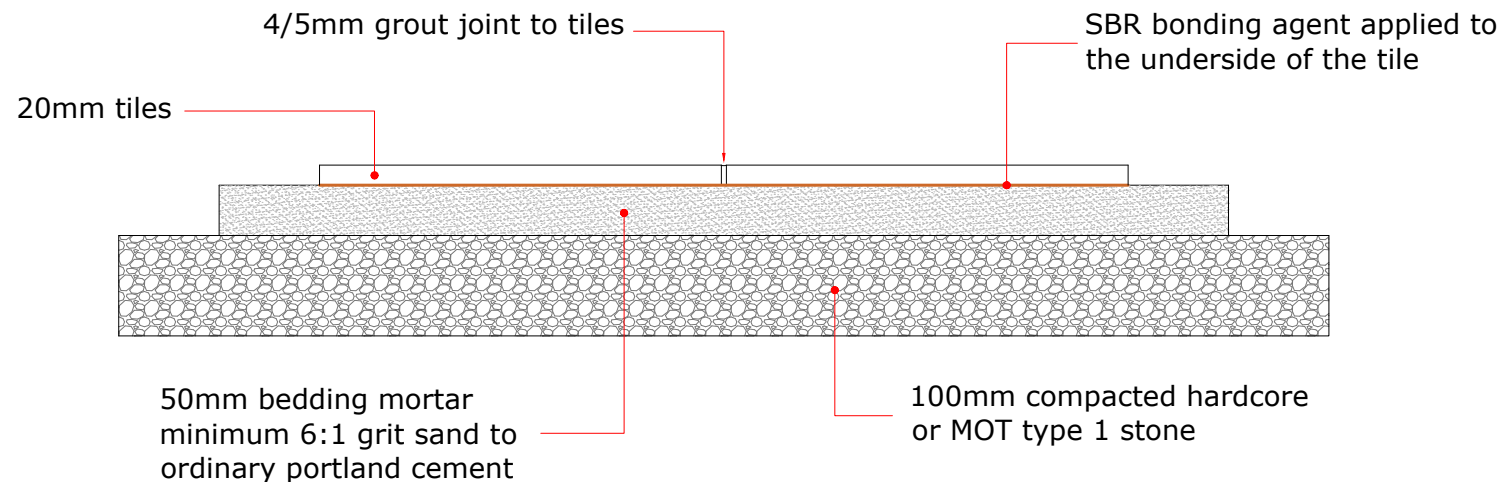

# Pack Types

## Mixed Paving Pack 600 Series

This pack contains our 4 most popular sizes (as detailed). The mixed pack is perfectly suitable for all projects whether large or small - always maintaining attractive proportions. The sizes within the packs enable a variety of random patterns (coverage 16.74m<sup>2</sup>).

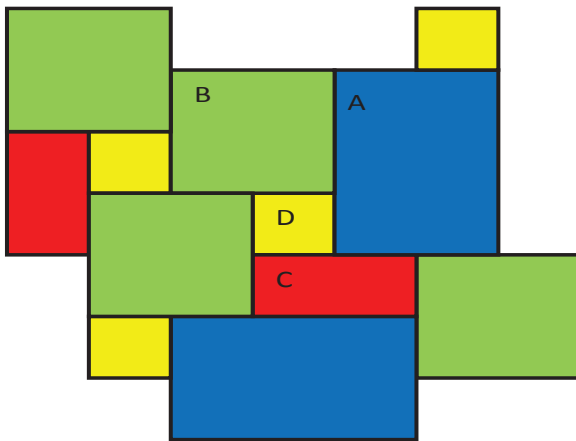

- (A) 900X600X25mm – 10pcs
  - (B) 600x600X 25mm – 20pcs
  - (C) 600x300X 25mm – 10pcs
  - (D) 295x295X25mm – 20pcs
- (5 MODULES PER PACK)

All sizes are nominal.  
We recommend a 10-15mm  
grout joint.

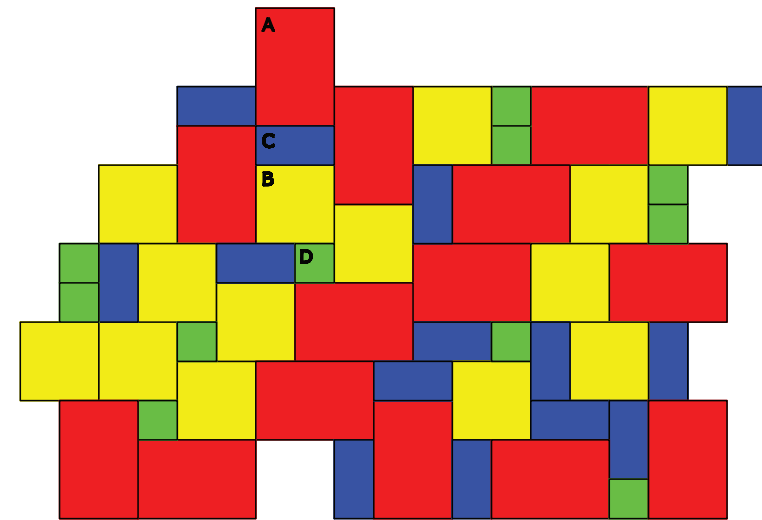

- (A) 900 X 600 MM - 14pcs
- (B) 600 X 600 MM - 14pcs
- (C) 600 X 290 MM - 14pcs
- (D) 290 X 290 MM - 11pcs

All sizes are nominal we recommend a 10-15mm grout joint

## Heritage Mixed Pack

To compliment our Danebury Natural Stone Coping, we have developed the Heritage mixed paving pack, which provides an easy to lay, attractive repeating modular pattern in one convenient pack. Each 16.08m<sup>2</sup> Heritage mixed pack (coverage 16.98m<sup>2</sup>) has 5 modules per pack.

# Terms and Conditions

The following terms and conditions are the terms on which Cranbourne Stone Limited ("the Company") sells goods and/or services and supersede all other terms and conditions used by the Company:

## 1. Orders

- A. All orders are subject to the approval of the Company which shall have an absolute discretion to accept or decline any order.  
B. No order which has been accepted by the company may be cancelled by the Purchaser except with the agreement in writing of the Company and on terms that the Purchaser shall indemnify the Company in full against all loss (including loss of profit), costs (including the cost of all labour and materials used), damages, charges and expenses incurred by the Company as a result of cancellation. For the avoidance of doubt any deposit paid by the Purchaser shall be non-returnable in the event of a cancellation.  
C. All orders are subject to these terms, which shall prevail over any terms proposed by the Purchaser.

## 2. Prices

- A. The price shall be the quoted price of the Company.  
B. However, the Company shall be entitled to adjust the price of any goods at the time of delivery of the goods or each instalment of the goods as the case may be:-  
(a) To take account of any direct or indirect price increases sustained by the Company including but not limited to currency fluctuations affecting the cost of imported materials or the cost of raw materials; and/or  
(b) If there is any change in the delivery date, quantities or specifications for the goods requested by the Purchaser or any delay caused by any instructions of the Purchaser or failure of the Purchaser to give the Company adequate information or instructions.  
C. Part Orders - The Company shall not be bound to accept orders for part only of a total quotation.

## 3. Delivery

- A. Any date for delivery named by the Company is an estimate only and the Company shall not be liable for the consequences of any delay. Every effort will be made to deliver in accordance with the dates endorsed on order acknowledgements but it is impossible for the Company to guarantee these dates and no claim will be entertained in respect of late delivery.  
B. In the event of the Purchaser failing to collect or refusing to take delivery, the Company shall be at liberty to invoice the purchaser for such goods and failure to settle such invoice within 30 days of the same being rendered shall entitle the Company to dispose of the goods as best it can giving credit to the Purchaser for any proceeds of sale received where after the Purchaser shall remain liable to the Company for any balance owing upon the invoice but the Company shall not be accountable to the Purchaser for any surplus should the amount raised on disposal of such goods exceed invoice value.  
C. The purchaser shall notify the Company at the time of placing the order if it wishes to arrange collection of the goods itself or arrange the delivery of the goods by an independent carrier to the premises specified by the Purchaser on its order.  
D. If the Purchaser arranges collection of the goods, delivery of the goods shall take place at the Company's works on the Purchaser or its agent being permitted to take possession of the goods. If the Company arranges delivery of the goods, delivery shall take place at the entrance to the premises specified by the Purchaser on its order.

## 4. Transport

- A. Where the Company arranges transport of the goods by road, the following terms shall apply:  
(a) Delivery shall only be required to be made to a hard standing deemed suitable by the lorry driver.  
(b) Prompt assistance shall be given by the Purchaser to the lorry driver in unloading goods, failing which the Company may make reasonable charge for excessive delay in waiting time. Where goods are undelivered due to no one being present on site to accept delivery, a re-delivery charge of £75 will apply.  
(c) Prices charged include a charge for loading of motor vehicles at the Company's works and a separate charge will be made to the premises specified, but the responsibility and cost of unloading shall be borne by the Purchaser.  
B. Where the Purchaser arranges collection of the goods from the Company, the Company shall notify the Purchaser when the goods are ready for collection, but shall not be responsible for any delay in transporting the goods after they have been despatched from the Company's works or for any damage occurring to the goods in transit.

## 5. Samples and Images

In submitting any sample or image of the goods to the Purchaser, the Company warrants only to give a general indication of the quality, colour, texture and/or type thereof and does not in so doing constitute any subsequent sale by sample. The Purchaser acknowledges and accepts that the Goods are made from a natural resource and variations in colour, shading, markings, texture, and size between consignments, will occur.

## 6. Risk and Property

- Subject to Condition 17, risk and property shall pass to the Purchaser:  
A. When collected by or on behalf of the Purchaser from the Company's works, on delivery to the Purchaser or its agent to take possession of the goods.  
B. When delivered by road by or on behalf of the Company to premises specified by the Purchaser, on delivery to the entrance of those premises.  
C. Until the date of payment, the Purchaser is, if the Company so desires, to store this material in such a way that it is clearly the property of the Company. The Company and Purchaser agree that, if the Purchaser should make (a) new object(s) from the material or mix this material with (an) other object(s) or if this material in anyway whatsoever becomes a constituent of (an) other object(s) then this will be used as surety for the full payment of what the Purchaser owes the Company. To this end the Company and Purchaser now agree that the ownership of the article(s) in question, whether finished or not, are to transfer to the Company and that this transfer of ownership will be considered to have taken place through and at the moment of the single operation or event by which the material is converted into (a) new object(s) or is mixed with or becomes a constituent of (an) other object(s). Until the moment of full payment of what the Purchaser owes the Company, the Purchaser shall keep the object(s) in question for the Company in his capacity of fiduciary owner and, if required, shall store this (these) object(s) in such a way that it (they) can be recognised as such. Nevertheless, the Purchaser will be entitled to sell these objects to a third party within the framework of the normal carrying on of his business and to deliver them on condition that, if the Company so requires, the Purchaser, as long as he has not fully discharged his debt to the Company, shall hand over to the Company the claims that he has against his buyer emanating from this transaction.

## 7. Packing Charges

In case of special orders, the Purchaser will be notified in writing when supplementary packing charges are applicable and the Purchaser shall have the right within seven days of any such notification to make its own arrangements for the collection of the goods, in which case the Purchaser will be solely responsible for the packing and loading of the goods.

## 8. Inspection

- A. Any signs of damage must be noted on the delivery note at time of delivery and notice of such be given immediately to the Company office and in any event within 24 hours.  
B. Quantity, type, shape, and size of the goods must be checked by the Purchaser or its agent at the earliest opportunity after delivery.  
C. All goods must have wrapping removed within 24 hours of delivery.  
D. Any objections to the goods on the grounds of incorrect quantity, type, shape or size must be notified to the Company before the goods are used or incorporated in any structure and in any event within 24 hours of delivery.  
E. The Company reserves the right not to accept responsibility for any delivery which has been made and which is incorrect by reason of incorrect quantity, type, shape or size.  
F. No guarantee can be given against naturally occurring variations, slight surface crazing or the phenomenon of efflorescence which may cause a temporary lightening to the colour of the stone.  
G. The Purchaser shall not be entitled to reject the goods where the alleged defect or breach of contract is so slight that it would be unreasonable for the Purchaser to reject the goods.  
H. Where any valid claim in respect of the goods is made by the Purchaser the Company shall be entitled to replace or repair the goods (or the part in question) free of charge or, at the Company's sole discretion, refund to the Purchaser the price (or a proportionate part of the price).  
I. In the event of any claim being made by the Purchaser, the Purchaser shall give the Company a reasonable opportunity to inspect the goods in the same condition as they were at delivery after discovery of the defect and liability will not be accepted unless this procedure is followed. For the avoidance of doubt, where the alleged defect is one which would have been apparent on reasonable inspection of the goods, liability for such defect will not be accepted where the Purchaser has used, cut, worked on or processed the goods in any way.

## 9. Fitness for Purpose

The Company makes no warranty as to the fitness of the goods for any particular purpose even if that purpose is stated in the Purchaser's order. This exclusion includes recommendations or advice from the Company to the Purchaser relating to a specific enquiry. The Purchaser must satisfy itself as to the fitness for the purpose for which the goods are intended. The Company will not be liable if the goods are not fit for the purpose required unless the Purchaser states the purpose in writing and the Company specifically confirms in writing that the goods are fit for such a purpose. In any event, where the Company arranges for the production of custom goods to the Purchaser's specification, no liability is accepted for the fitness of the goods for any particular purpose.

## 10. Returns

The Company may at its discretion accept the return of goods provided that the goods are:  
A. Undamaged, unused, uncut or in any other way unworked; and  
B. Returned at the Purchaser's expense within 3 days of delivery.

No goods may be returned for Credit except by special arrangements with the Company and any attempt to do so will be entirely at the Purchaser's risk. Where the Company accepts the returned goods it shall at its option either give credit or refund the price to the Purchaser in each case less a 20% re-stocking charge.

## 11. Payment

Credit accounts may be opened, subject to satisfactory credit references being obtained, in our sole discretion. Payment for goods supplied on a credit account shall be due and payable not later than 30 days from the date of invoice. Payment for Natural Stone orders is required prior to dispatch. Bespoke and/or large orders will require a 50% deposit to confirm order. The Company reserves the right to stop further supplies if these terms of payment are not observed and to charge interest on all overdue accounts at a rate equal to 5% above the minimum lending rate of the Company's bankers.

## 12. Supply of Plans to the Company

Where the Purchaser submits plans and specifications for the goods to the Company, quotations are made in accordance with such plans and specifications. The Company shall not be under any obligation to check or verify the accuracy or adequacy of any such plans or specifications. The Purchaser guarantees the accuracy of all dimensions contained in such plans and specifications and shall indemnify the Company against loss arising directly or indirectly from any error, inaccuracy, omission or other fault on the part of the Purchaser or person, firm or company responsible for the preparation of such plans and specifications.

## 13. Preparation of Drawings by the Company

Where the Purchaser supplies such plans and specifications the Company may prepare shop drawings for the goods and shall, within the time (if any) specified in the job schedule (if any) submit such drawings to the Purchaser for procurement of the written and signed approval thereof from the architect and/or general contractor of the project. He, the Purchaser, shall within such time as may be specified, return to the Company the said drawings containing such approval as aforesaid and the Company shall make the goods in accordance with such approved drawings. The Company shall have no responsibility for or with respect to the adequacy of such drawings after they have been approved as aforesaid.

## 14. Indemnity

Notwithstanding any other provision herein, the Purchaser shall indemnify and reimburse the Company for any losses incurred by the Company as a result of any delay in any delivery schedule agreed upon by the parties which is caused by any delay in furnishing to the Company of such drawings as aforesaid.

## 15. Purchaser's Failure to take Delivery

If the Purchaser fails to take delivery of the goods in accordance with the delivery schedule (if any) agreed upon by the Company and the Purchaser and such goods are ready for delivery to the Purchaser and the Purchaser's failure to take delivery is not excused under section 3, all risks of loss of, damage to and deterioration of such goods shall pass to the Purchaser upon dates of delivery specified in the delivery schedule.

## 16. Responsibility for Design of Structure

The Company shall have no responsibility or liability whatsoever with respect to the adequacy of the design of the structure in which the goods supplied by the Company will be used and the Purchaser will, at the Purchaser's sole expense, defend, hold harmless and indemnify the Company against all liabilities, expenses or damages and claims arising out of any proved or alleged inadequacies.

## 17. Warranties made by the Company

No warranty, express or implied, is made by the Company. In the case of a consumer sale, these conditions shall have effect only in so far as they are consistent with the consumer's statutory rights.

## 18. Limitation of Liability

- A. Save in respect of personal injury or death due to any negligence, the Company shall not be liable to the Purchaser in respect of any loss suffered by the Purchaser due to any defect in the goods.  
B. Without prejudice to condition 18A and for the avoidance of doubt, the Company shall not be liable to the Purchaser or any third party for any loss of profit, consequential or other economic loss suffered by the Purchaser arising in any way from this Agreement.

## 19. Set Off and Counterclaim

The Purchaser may not withhold payment of any invoice or other amount due to the Company by reason of any right of set off or counterclaim which the Purchaser may have or allege to have for any reason whatsoever.

## 20. Force Majeure

The Company shall not be liable for any default due to any circumstance beyond the reasonable control of the Company including, but not limited to, Acts of God, war, civil unrest, riot, strike, shipping delays, lock out, acts of civil or military authorities, fire, flood, earthquake or shortage of supply.

## 21. Customer's Default

This condition applies if:

- A. The Purchaser makes any voluntary arrangement with its creditors or (being an individual or firm) becomes bankrupt or (being a company) becomes subject to an administration order or goes into liquidation (otherwise than for the purposes of amalgamation or reconstruction); or  
B. An encumbrancer takes possession or a receiver is appointed, of any of the property or assets of the Purchaser; or  
C. The Purchaser ceases, or threatens to cease, to carry on business; or  
D. The Company reasonably apprehends that any of the events mentioned above is about to occur in relation to the Purchaser and notifies the Purchaser accordingly; or  
E. The Purchaser fails to pay the price or any additional charges or any part thereof in accordance with condition 2.

Where this condition applies then, without prejudice to any other right or remedy available to the Company, the Company shall be entitled to cancel the contract and all other contracts which may exist between the Company and the Purchaser and suspend any further deliveries or performance under the contract and any other contracts without any liability to the Purchaser, and if the goods (or goods subject to any contract which may exist between the parties) have been delivered but not paid for, the price, any additional charges and any other sums payable by the Purchaser shall become immediately due and payable notwithstanding any previous agreement or arrangement to the contrary.

## 22. General

- A. If any term or provision of these conditions is held invalid, illegal or unenforceable for any reason by any Court of competent jurisdiction, such provision shall be severed and the remainder of the provisions hereof shall continue in full force and effect as if these conditions had been agreed with the invalid, illegal or unenforceable provision eliminated.  
B. The Company may without the consent of the Purchaser sub-licence its rights or obligations or any part of these conditions.  
C. The headings in these conditions are for ease of reference only and shall not affect the interpretation of any of the conditions.

## 23. Contract

Notwithstanding any other provision of this agreement, nothing herein shall confer or is intended to confer a benefit on any third party for the purpose of the Contract (Rights of Third Parties) Act 1999 or for any other purpose.

## 24. Entire Agreement

Each of the parties agrees that save in respect of statements made fraudulently it shall have no remedy in respect of any untrue statement upon which it relied in entering this Agreement and that its only remedies shall be for breach of contract.

## 25. Governing Law and Jurisdiction

The laws of England and Wales shall govern this Agreement and the parties hereby submit to the exclusive jurisdiction of the courts of England and Wales.

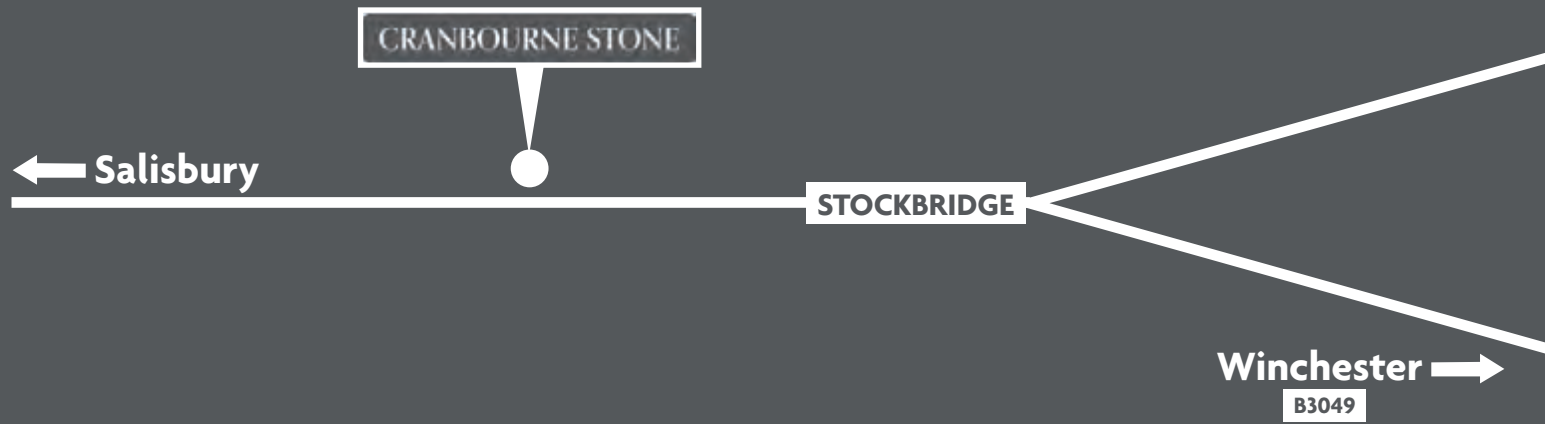

Your Local Stockist is:

Unit 1 • Houghton Down Farm • Stockbridge • Hampshire • SO20 6JR  
Tel: 01264 810813 • Fax: 01264 810814 • Email: [enquiries@cranbournestone.co.uk](mailto:enquiries@cranbournestone.co.uk)

[www.cranbournestone.co.uk](http://www.cranbournestone.co.uk)