

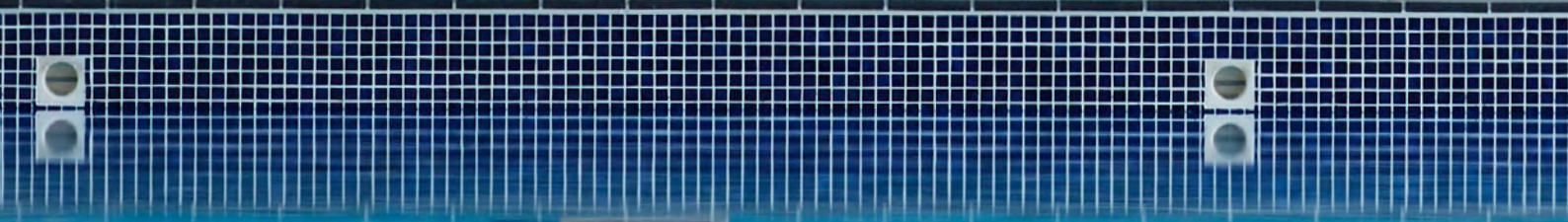

designworks:tiles

~ pool essentials



# Welcome

Be Inspired  
04-07

Pool BRICKS  
Pool Bricks 11  
Pool Mouldings 13

JointPoint® MOSAICS  
Niebla 14  
Lisa 18

JointPoint® SAFE STEP MOSAICS  
Safe Step Mosaics 21  
Niebla Safe Step 22  
Safe Step Roll Edges 24  
JointPoint® System 25

Classic Paper Faced MOSAICS  
Plain Glass 26  
Iridescent 26  
Gold Fleck 27

Poolside TILES  
Dorset Woolliscroft Slip Resistant Tiles 30  
Dorset Woolliscroft Fittings 36  
Wood-Effect 39  
Savana 40  
Soft Earth 41  
Broadway Lime & Slate Chiara 42

Looking for MORE?  
Ultimate Pool & Spa 43

Information  
Bespoke Finishing 44  
Safety Testing 45  
Important Information 46  
Essential Fixing Products 46

## Key for symbols

 Pools & hot tubs  
(suitable for submersion)

 Wet & dry walls  
(inc showers & wet rooms)

 Wet & dry floors  
(inc showers & wet rooms)

 Internal use only

 Internal & external use

Indoors or outside, small or large, residential or commercial, a swimming pool can add so much. For some, a pool provides a peaceful oasis, somewhere to relax and entertain. A commercial swimming pool can be for serious fitness training, part of a school or college, a valuable community resource, or a vital element within a luxurious health spa, hotel complex or leisure centre.

Whatever type of pool your customers are looking for, here's your essential guide to tiles and mosaics, fixtures, fittings and finishes for all things pool, pool side and spas.

DIVE IN.

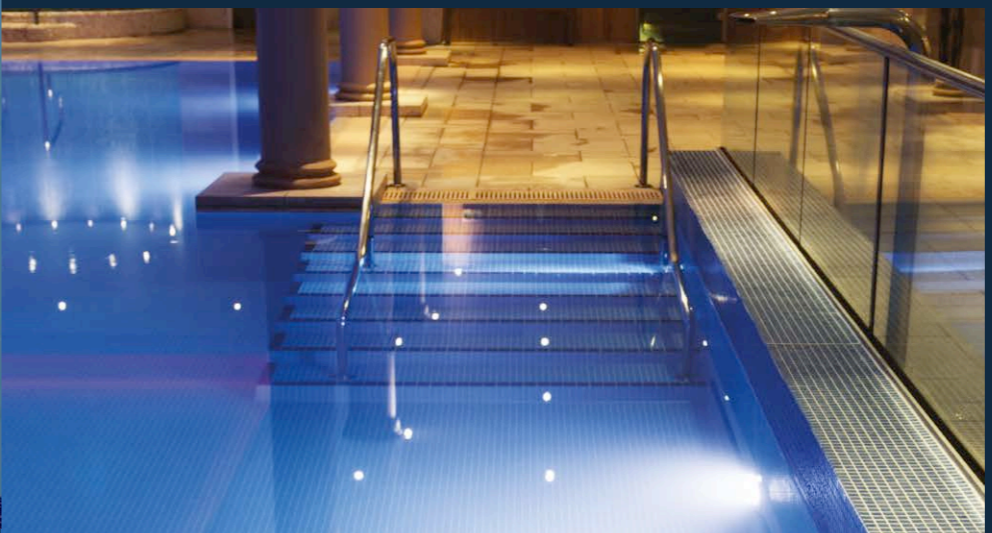
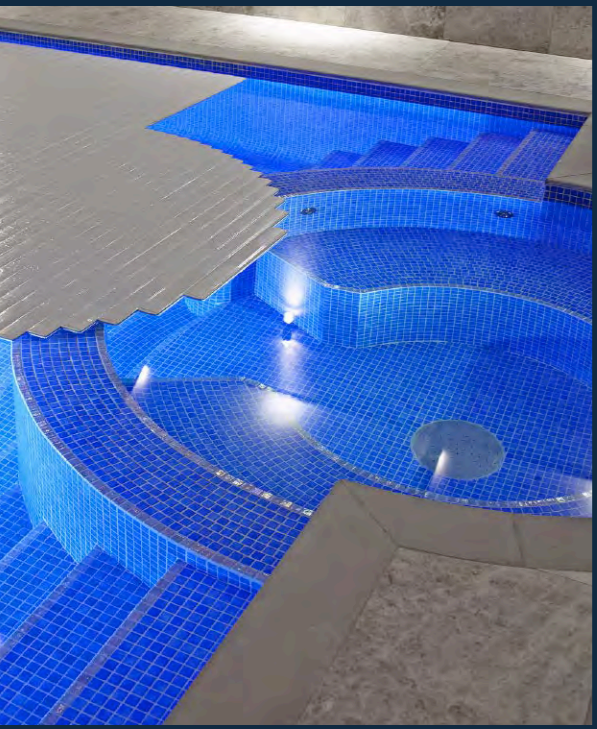
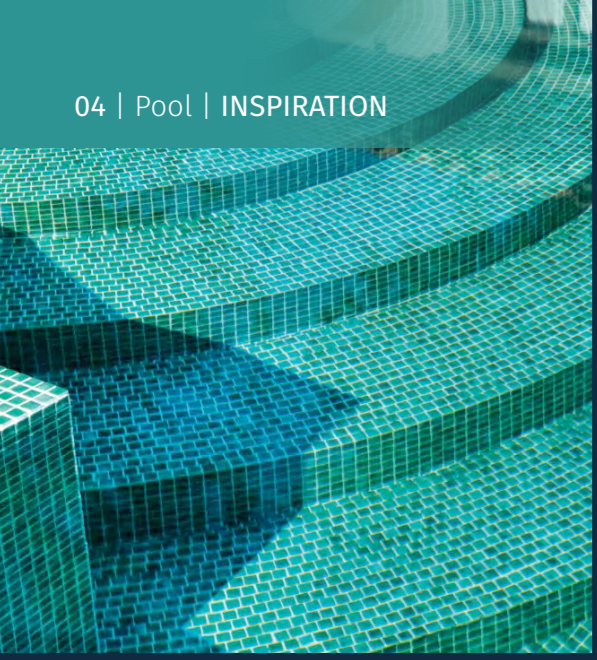

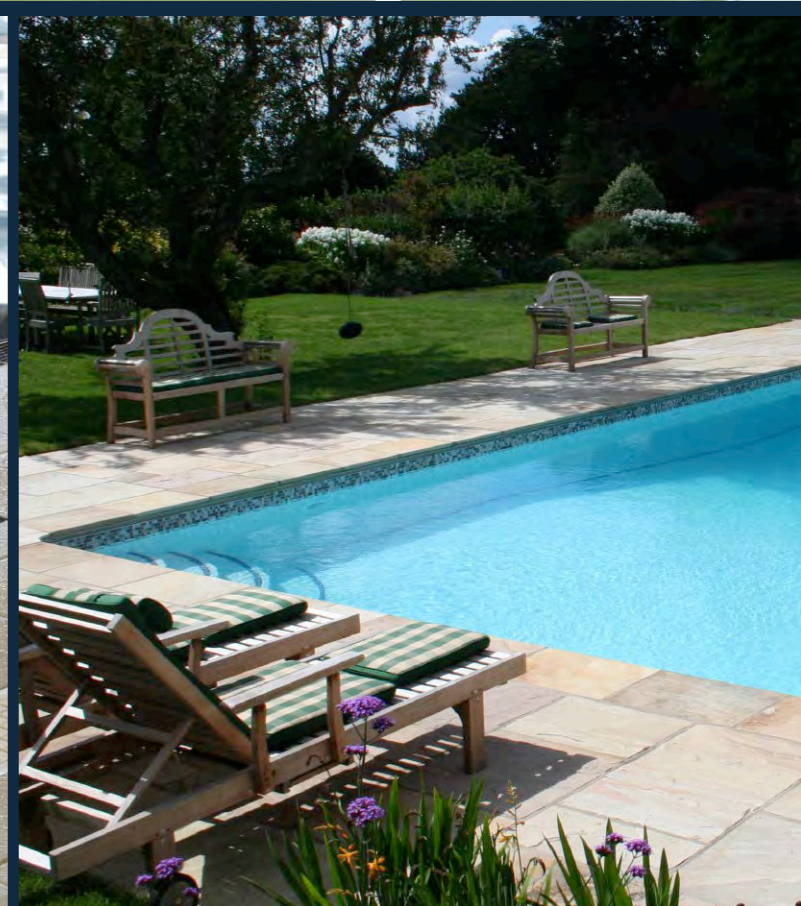
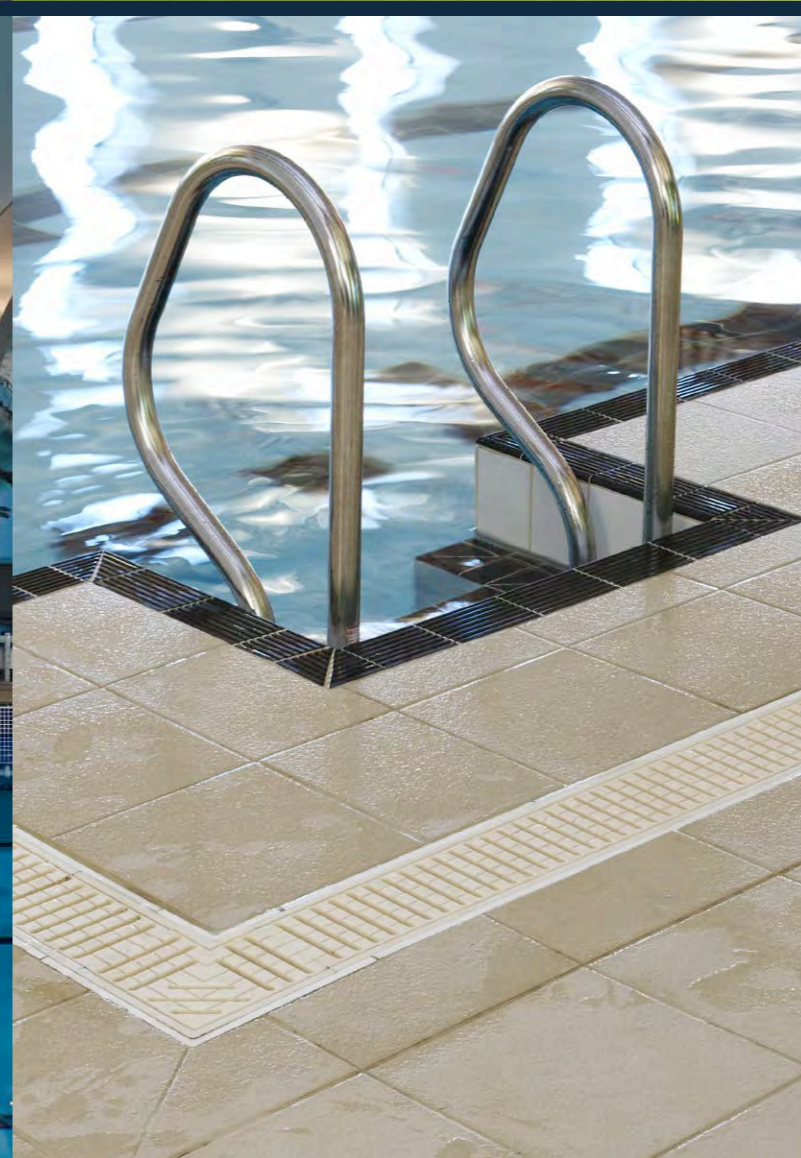
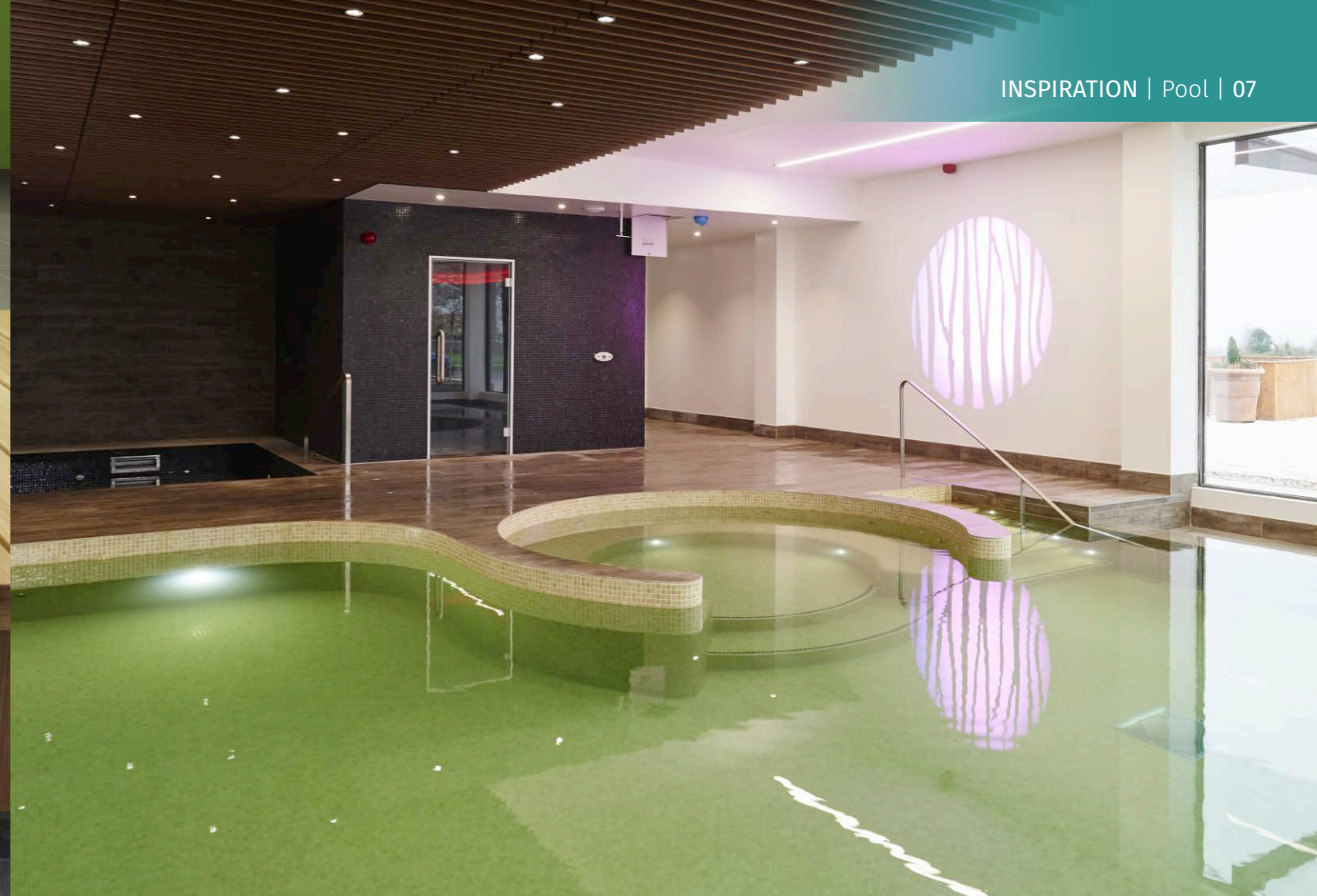
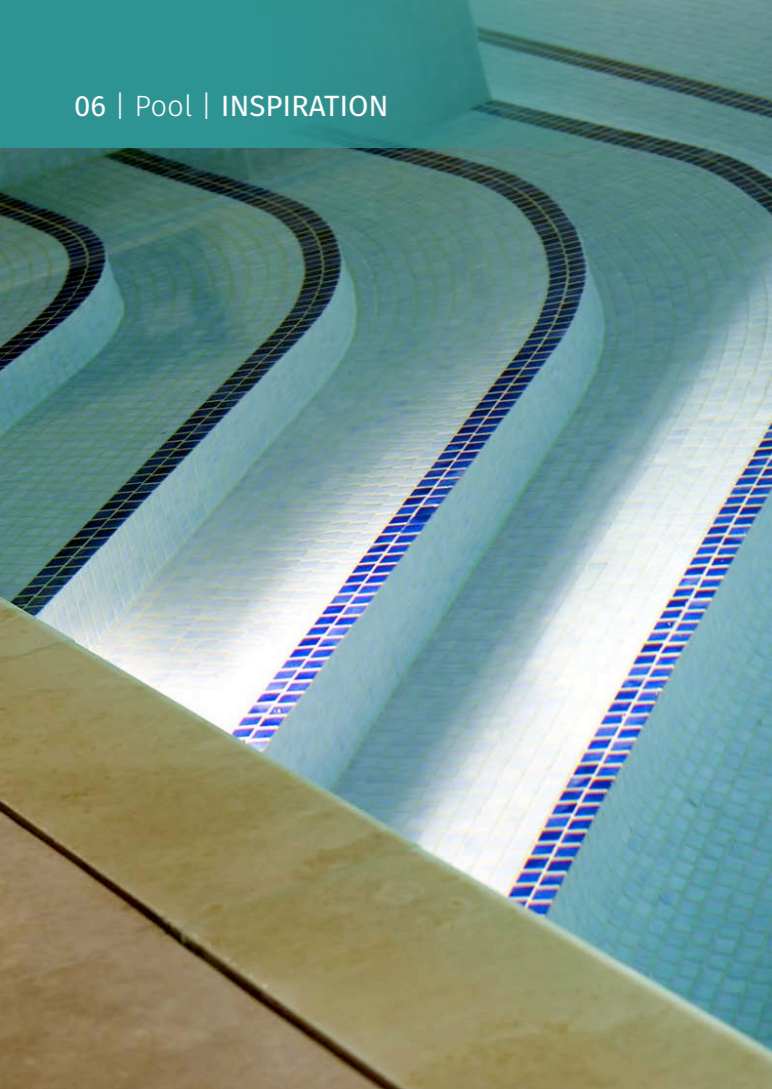

Inspired? The following pages show just some of our brick tiles and mosaic collections for pools and spas.

# Pool Tiles & Mosaics

hidden depths

from versatile pool bricks to sumptuous glass  
mosaics, all with slip-resistant options





# Pool Bricks

Simplicity and versatility for in and around the pool – perfect for community spaces.

- Gloss and slip-resistant finishes are available in three colours
- Contrasting tones are ideal for lane marking or for adding design detail
- Co-ordinating high performance mouldings available (see following page)
- Structured, unglazed option

## Gloss

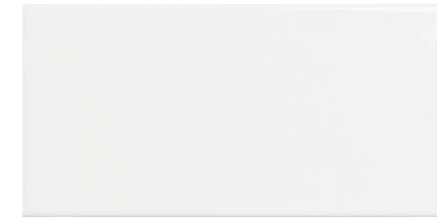

**WHITE GLOSS**  
CS813-2512  
250 x 125 x 6mm



**LIGHT BLUE GLOSS**  
CS814-2512  
250 x 125 x 6mm



**COBALT BLUE GLOSS**  
CS815-2512  
250 x 125 x 6mm



## Slip-resistant

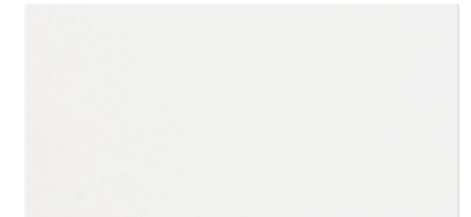

**WHITE SLIP RESISTANT**  
CS813-2512-AS  
245 x 120 x 6mm

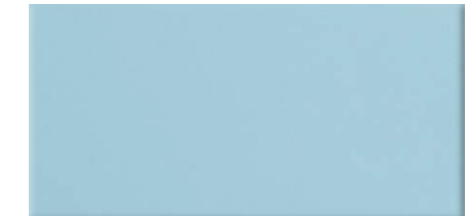

**LIGHT BLUE GLOSS**  
CS814-2512-AS  
250 x 125 x 6mm



**COBALT BLUE GLOSS**  
CS815-2512-AS  
250 x 125 x 6mm

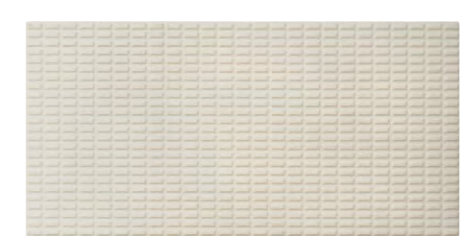

**STRUCTURED UNGLAZED**  
CS818-2512  
245 x 120 x 6mm



# Cobalt Pool Mouldings

Co-ordinates with the Pool Brick range (see previous page)

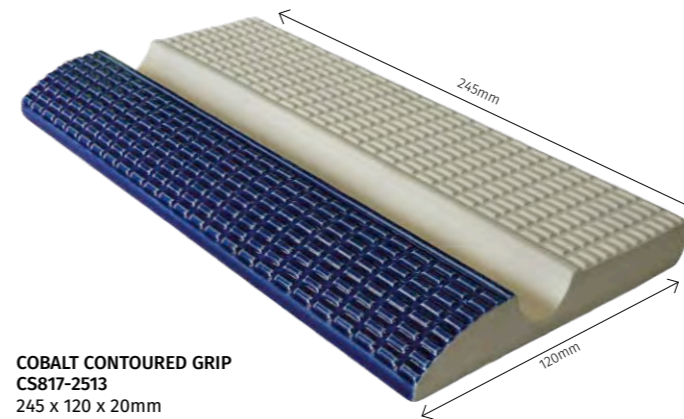

**COBALT CONTOURED GRIP**  
CS817-2513  
245 x 120 x 20mm

A deep unglazed channel and large glazed edge ensure comfortable and effective grip.

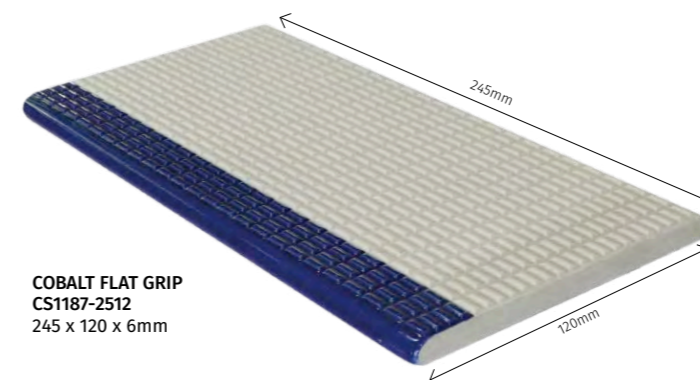

**COBALT FLAT GRIP**  
CS1187-2512  
245 x 120 x 6mm

Partially glazed and rounded at the edge. Ideal for step or pool edging.

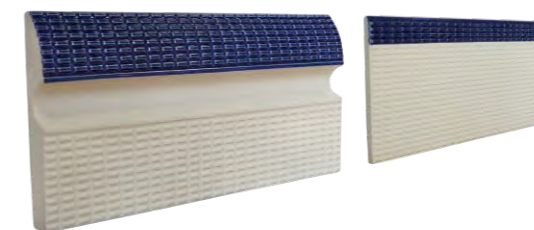

Both are suitable for use vertically as skirting pieces

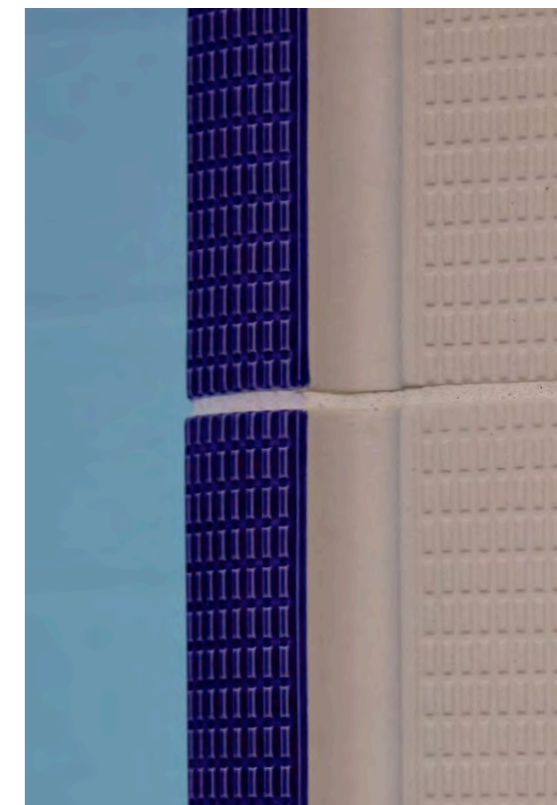

# Niebla 25mm, 36mm, 50mm

Flowing colours, variations of light and tone and plenty of choice from our most popular range

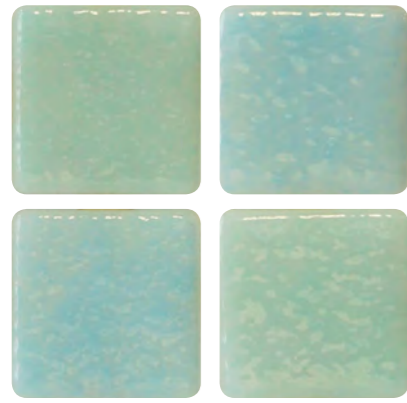

SM-2518MOS ◊  
3618

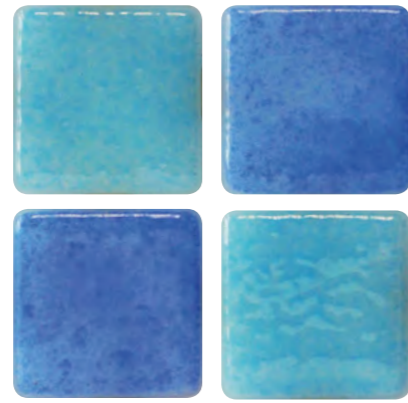

SM-25004MOS (Colour mix 25mm only)

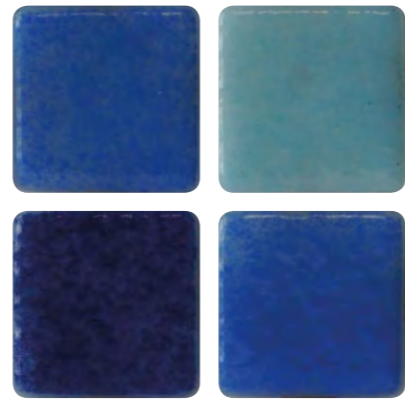

SM-25002MOS (Colour mix 25mm only)

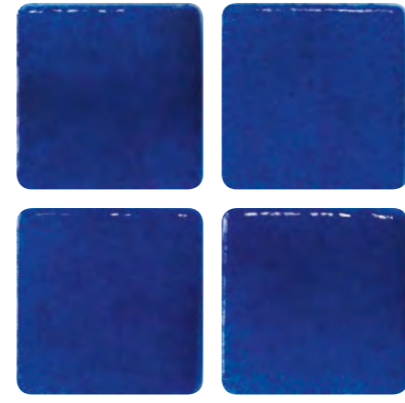

SM-2512MOS  
3612-C  
5012-C

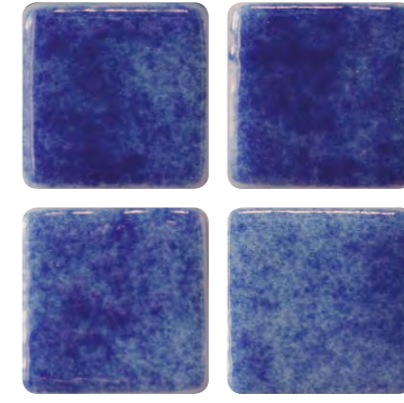

SM-2562MOS ◊  
3662-B  
5062-B

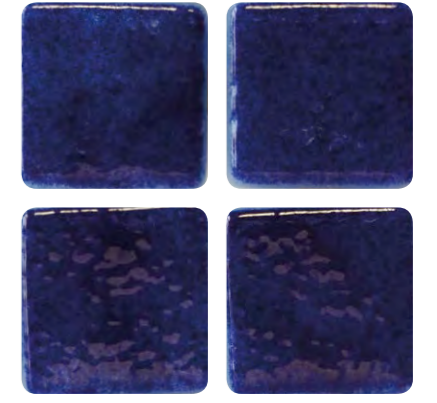

SM-2503MOS  
3603-D  
5003-D



SM-2529MOS  
3629-B  
5029-B

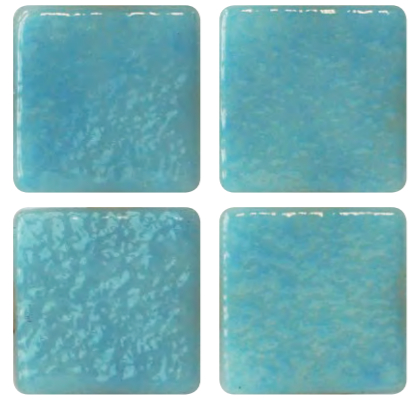

SM-2508MOS ◊  
3608-A  
5008-A

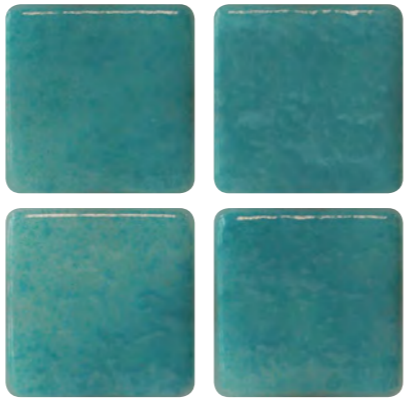

SM-2510MOS  
3610-A  
5010-A

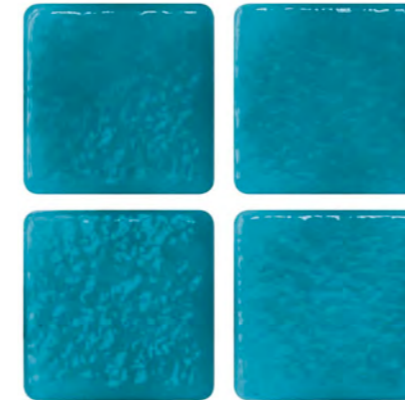

SM-2502  
3602-A  
5002-A



SM-2505MOS ◊  
3605-A  
5005-A



SM-2521MOS  
3621-B  
5021-B



SM-2507MOS  
3607-A  
5007-A

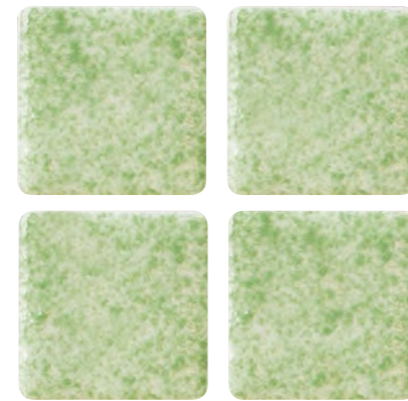

SM-2585MOS  
3685-B  
5085-B

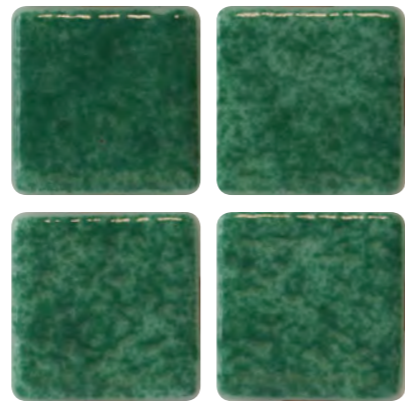

SM-2586MOS  
3686-B  
5086-B

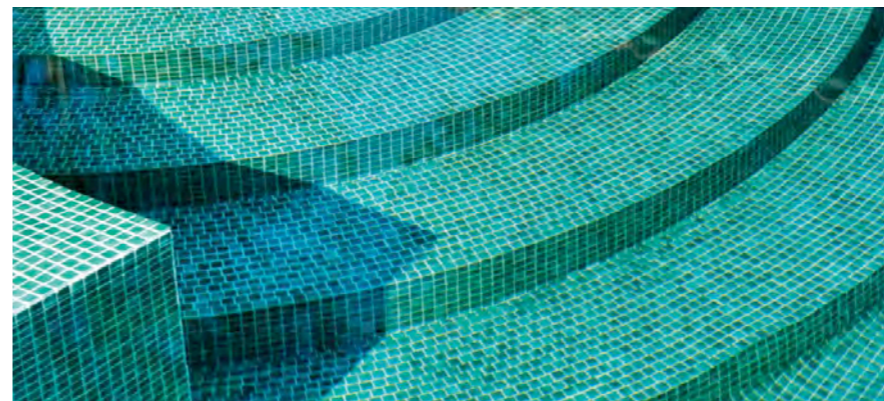

▲ SM-2586MOS



SM-2522MOS  
3622-B  
5022-B

Mosaics featured on these, and the following pages use JointPoint® – an innovative system of flexible silicone joints that hold the individual mosaics together in sheets. JointPoint® offers a number of advantages over traditional mosaic sheet manufacture. Turn to page 21 for further details.

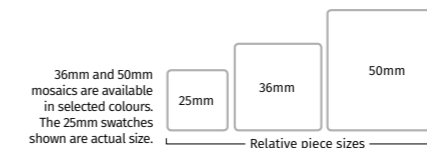

◊ These products are available from stock. All other mosaics on this page have a two week lead time.

◊ These products are available from stock. All other mosaics on this page have a two week lead time.





# Niebla 25mm, 36mm, 50mm

Blue pools are certainly beautiful, but why stop at blue? There are plenty more Niebla colours

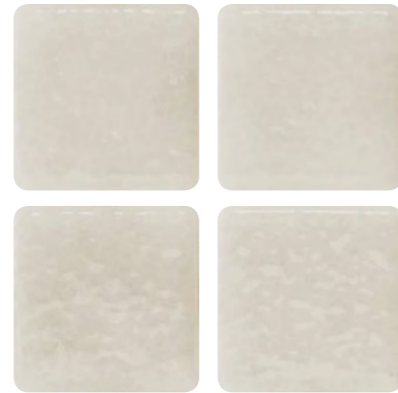

2523-B  
3623-B  
5023-B

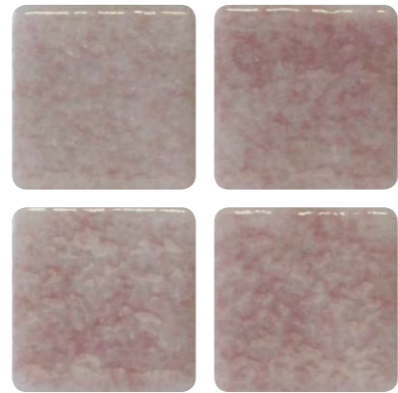

2524-B  
3624-B  
5024-B

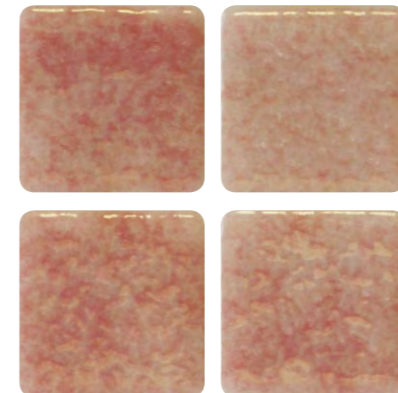

SM-2564MOS  
3664-B  
5064-B

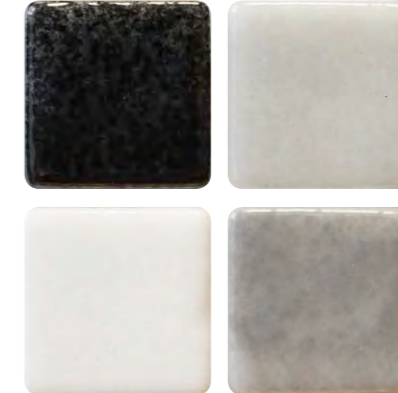

SM-25008MOS (25mm only)

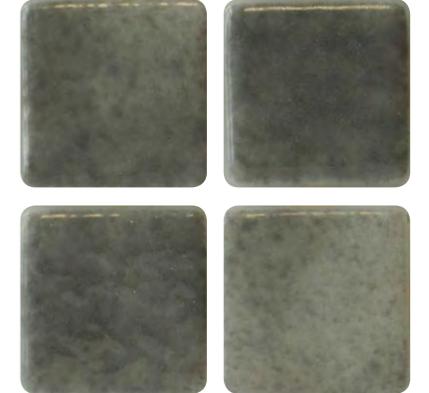

SM-2560MOS  
3660-A  
5060-A



SM-2596MOS  
3696-B  
5096-B



SM-2597MOS  
3697-B  
5097-B



SM-2576MOS  
3696-B  
5096-B



2511-A  
3611-A  
5011-A

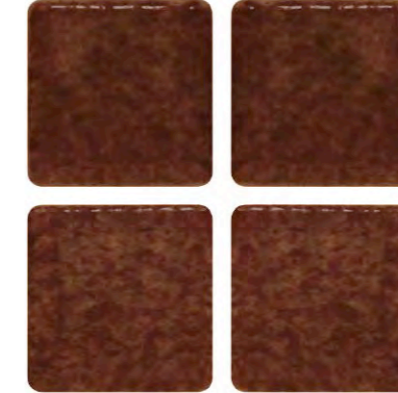

2504-A  
3602-A  
5002-A

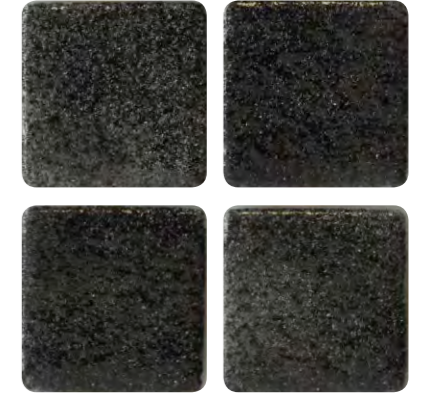

SM-2516MOS  
3616-B  
5016-B



2525-B  
3625-B  
5025-B



SM-2526MOS  
3626-B  
5026-B



2513-A  
3613-A  
5013-A

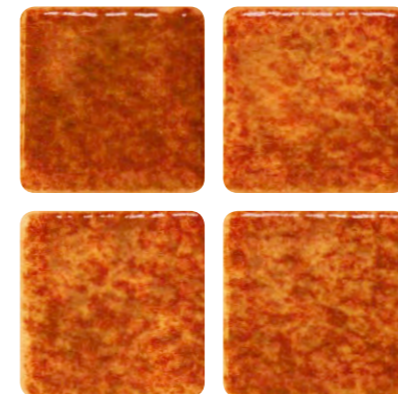

2509-C  
3609-C  
5009-C

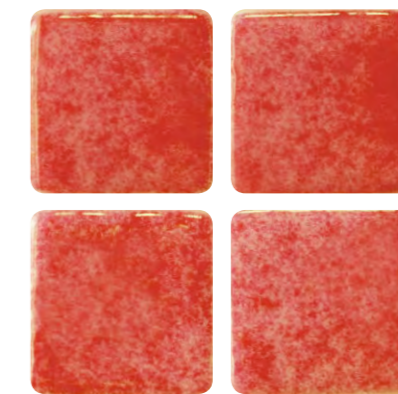

SM-2506MOS  
3606-C  
5006-C

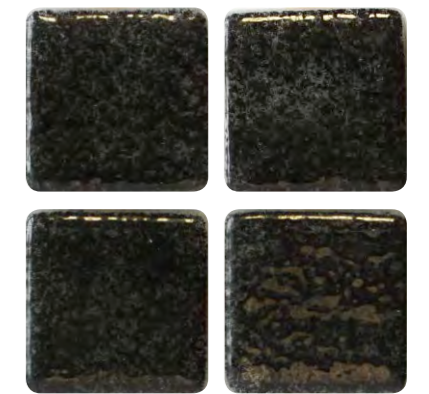

SM-2501MOS  
3601-B  
5001-B

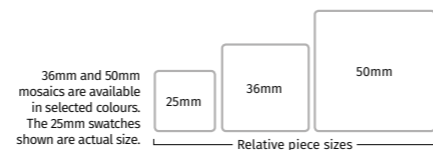

◊ These products are available from stock. All other mosaics on this page have a two week lead time.

◊ These products are available from stock. All other mosaics on this page have a two week lead time.

# Lisa 25mm, 36mm, 50mm

Pure and vibrant colours to use on their own, or to contrast and define



2541-A  
3641-A



2547-A  
3647-A



SM-2534MOS  
3634-A



SM-2545MOS ◊  
3645-A  
5045-A



SM-2551MOS  
3651-A



2546-A  
3646-A



SM-2535MOS  
3635-A

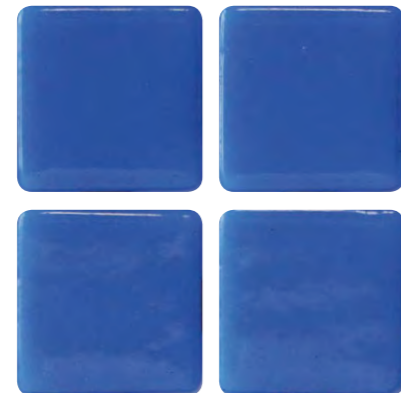

SM-2542MOS  
3642-B



2536-C  
3636-C



2549-A  
3649-A



2548-C  
3648-C



SM-2555MOS  
3655-C



2557-D  
3657-D



2556-C  
3656-C

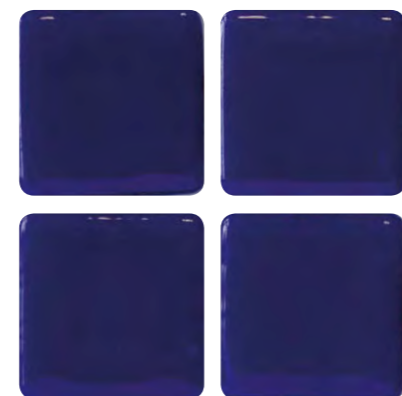

SM-2543MOS  
3643-D



2544-A  
3644-A



SM-2559MOS  
3659-B



SM-2530MOS ◊  
3630-D

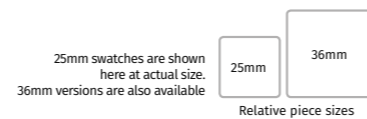

◊ These products are available from stock. All other mosaics on this page have a two week lead time.

◊ These products are available from stock. All other mosaics on this page have a two week lead time.

Lisa 25mm, 36mm



2552-A  
3652-A



2553-B  
3653-B



2539-B  
3639-B



2554-C  
3654-C



2533-A  
3633-A



2558-B  
3658-B



2532-B  
3632-B



2531-B  
3631-B



SM-2538MOS  
3638-D



SM-2537MOS  
3637-E

25mm swatches are shown here at actual size. 36mm versions are also available. Relative piece sizes

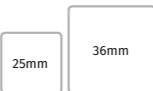

▲ Special mix of Iris Coral and Jade Antislip

# Safe Step Mosaics

Step edges, wet room and steam room floors can all be both stylish and safe with these slip resistant mosaics. A wide range of colours means they can be used to co-ordinate or contrast with other shades. Featuring a newly developed surface called 'Safe Step', these mosaics offer a softer, more foot friendly feel while maintaining good levels of slip resistance.

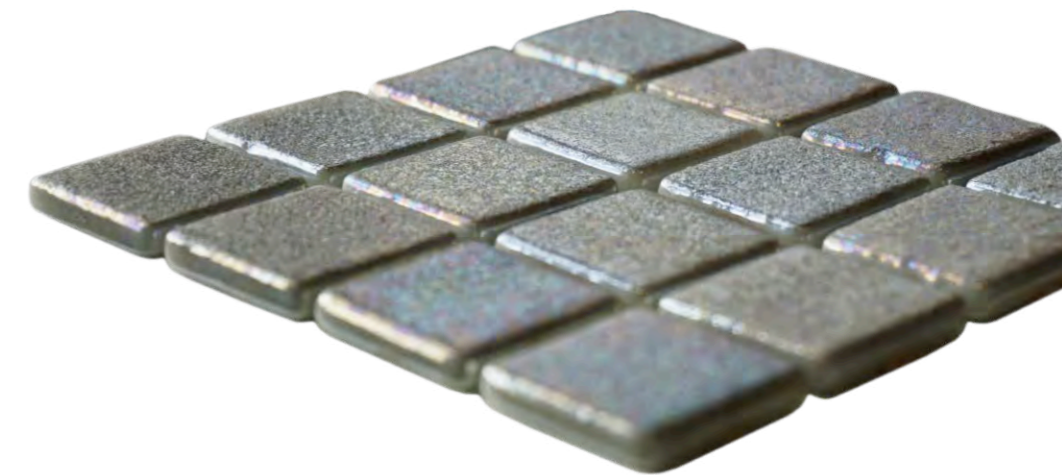

# Niebla Safe Step <sup>new</sup> 25mm, 36mm, 50mm

These mosaics feature the latest 'Safe Step' slip resistant technology for optimum comfort, beauty and safety.



SM-2545MOS-SAS <sup>◊</sup>  
SM-5045MOS-SAS



2522-SAS



2529-SAS

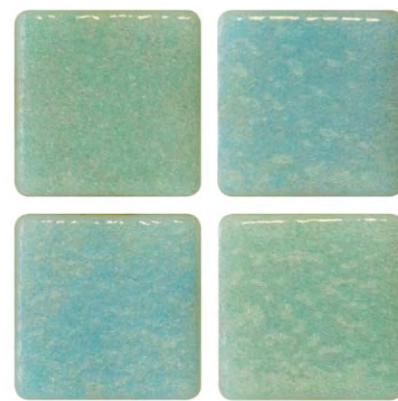

SM-2518MOS-SAS



SM-2521MOS-SAS



SM-2560MOS-SAS <sup>◊</sup>  
SM-5060MOS-SAS



SM-2516MOS-SAS <sup>◊</sup>  
SM-5016MOS-SAS



SM-2504MOS-SAS



2507-SAS



SM-2505MOS-SAS <sup>◊</sup>

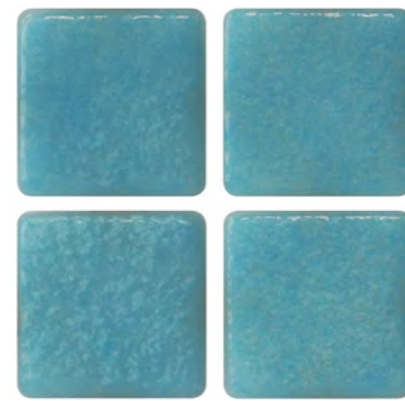

SM-2508MOS-SAS



SM-2576MOS-SAS <sup>◊</sup>



2511-SAS

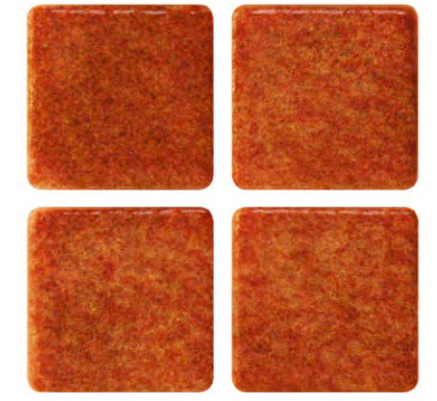

2509-SAS



2502-SAS  
3602-SAS

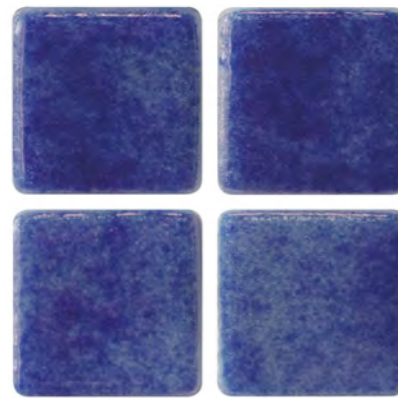

2562-SAS

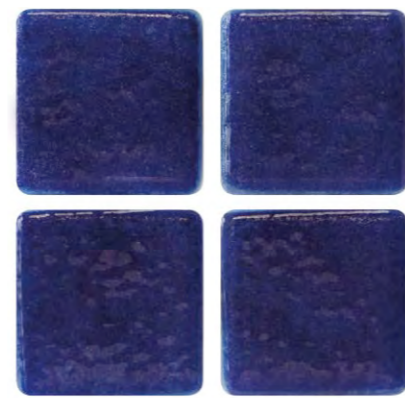

SM-2503MOS-SAS <sup>◊</sup>



SM-2596MOS-SAS  
SM-5096MOS-SAS

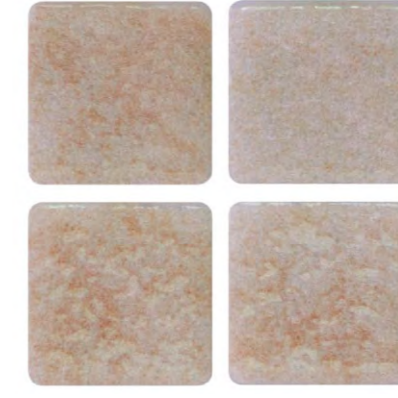

2523-SAS



2514-SAS

**Technical characteristics**  
Tested to: BS7976-2  
Barefoot Wet (TRRL55 Wet) >44

<sup>◊</sup> These products are available from stock.  
All other mosaics on this page have a two week lead time.

<sup>◊</sup> These products are available from stock.  
All other mosaics on this page have a two week lead time.

**Technical characteristics**  
Tested to: BS7976-2  
Barefoot Wet (TRRL55 Wet) >44



## Niebla Safe Step Roll Edges

Featuring the latest innovation in slip resistant technology, these innovative corner pieces provide a seamless and safe edging for the transition from poolside to pool and for step areas

At 52mm in length, the pieces are also small enough to be used effectively to create curves. Sharp edges are completely eliminated with these corner pieces.

- Available in a useful range of colours plus a glow-in-the-dark option
- Use in contrast or co-ordinate with any of the JointPoint® mosaic ranges
- New low-abrasion Safe Step finish
- Slip resistant for safety
- For pool edges both straight and curved, and step edges
- Attractive finishing piece
- Easy to install at the same time as the tiling

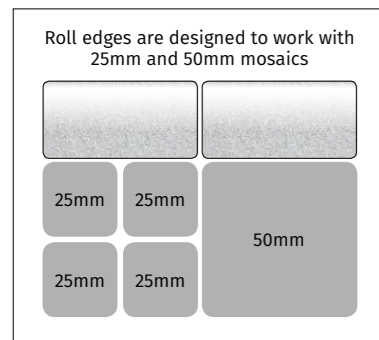
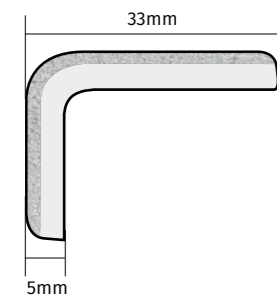
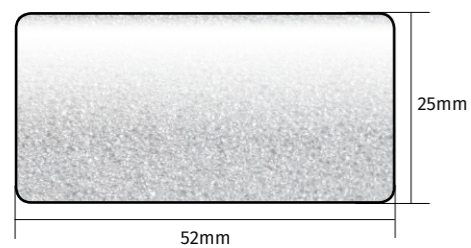
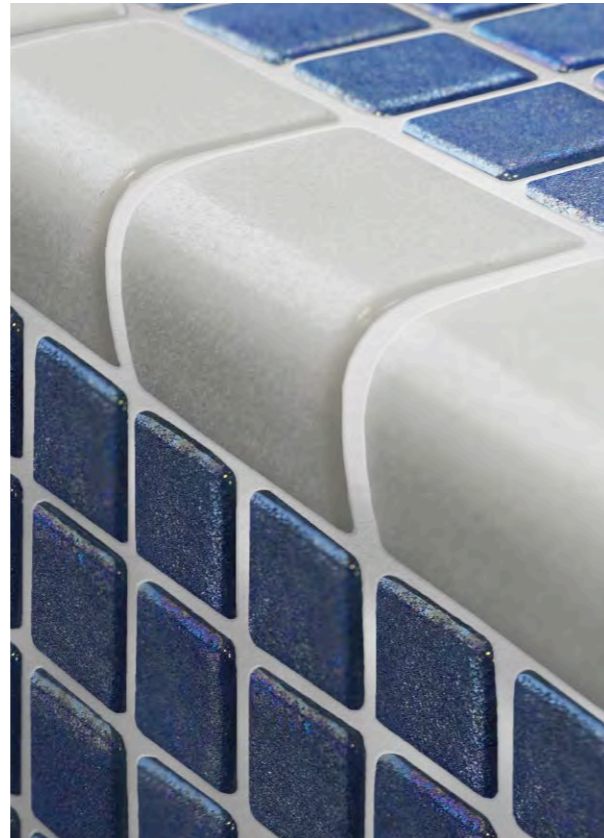

Roll Edges are available from stock.



## The JointPoint® System

JointPoint® is a technologically advanced system where silicone points are used to join individual mosaics together into panels (the points are on the reverse of the panel or sheet). Designed to ensure that the sheets are laid uniformly, up to 92% of the surface is left free for the application of adhesive, which results in better adhesion and superior grip. JointPoint® is very easy to work with and install – the sheets are flexible and controllable.

**WATER IMMERSION TENSILE ADHESION STRENGTH**  
Each family type of mesh/glue backing system for mosaic tiles, recommended for water submerged conditions (not salt water), is tested in accordance with BSEN 1348:2007 Determination of Tensile Adhesive Strength for Cementitious Adhesives.

The tests are conducted by a UKAS accredited testing laboratory, number 0013. The mean value of water immersion tensile adhesion strength is determined for each family type of mesh/glue backing system after allowing for any discarded samples.

BSEN 12004-1 states that the tensile values for a C2 adhesive must be greater than or equal to 1.0 N/mm<sup>2</sup>. Each family type of mesh/glue backing system meets this requirement. For example, the JointPoint® family type of mesh/glue backing system yielded a result of 1.3 N/mm<sup>2</sup>.

It must be noted that each family mesh/glue backing system for mosaics is tested using Ardex x77 C2 adhesive. All test materials, including the adhesive being tested, were conditioned as required by the test method BSEN 1348:2007. The Ardex x77 adhesive was prepared in accordance with clause 7.0 of the EN 1348 standard.

Ardex x77 C2 adhesive is the recommended product for use with all JointPoint® Designworks/Original Style swimming pool mosaic tiles installed in submerged conditions. For salt water swimming pools we recommend the use of an epoxy adhesive only.

All mosaics shown on pages 14-23	
Individual tile size	Sheet size
25 x 25 x 5mm	312 x 495mm
36 x 36 x 5mm	334 x 334mm
50 x 50 x 5mm	365 x 365mm
98% of the glass used as a raw material in the production process is recycled	

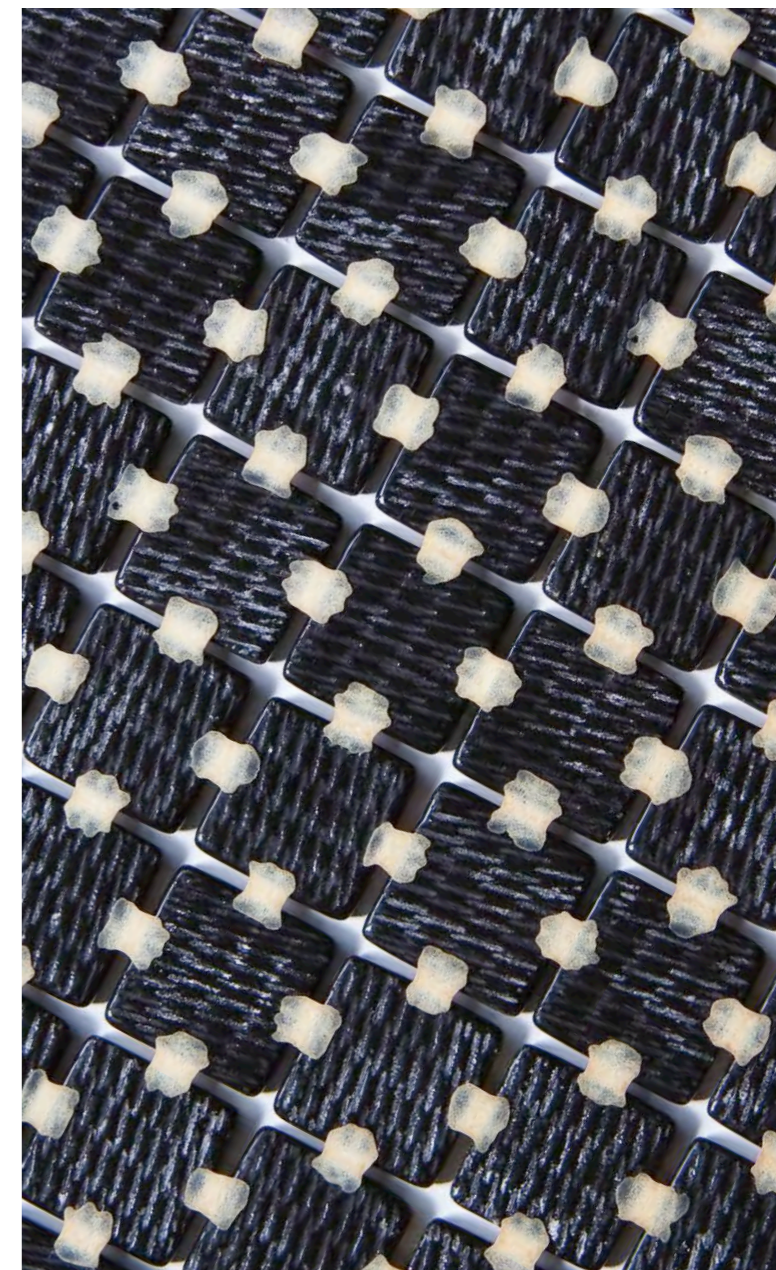

JointPoint®

# Classic Paper Faced Mosaics

## Plain glass 20mm

A soft blend of aquatic blues

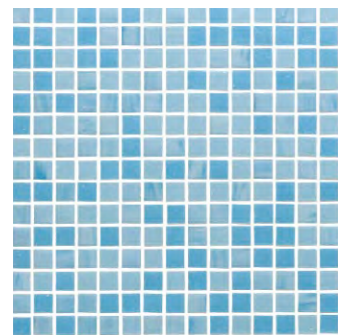

**CAICOS** | SM-CAIMOSPF  
327 x 327 x 4mm



## Iridescent glass 20mm

Iridescence has a natural affinity to water, and its beauty has been captured in these mosaics — use them in a pool or on shower walls and enjoy their ever-changing shimmer and shine

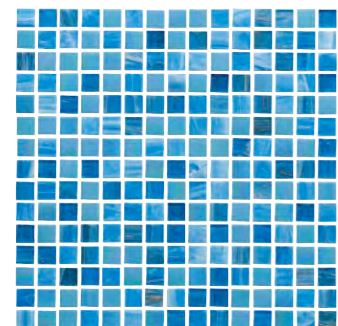

**ST KITTS** | SM-STKMOSPF  
327 x 327 x 4mm

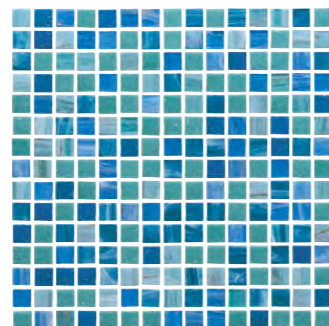

**ST LUCIA** | SM-STLMOSPF  
327 x 327 x 4mm

## Gold fleck glass

Rich, blended colours with glittering gold accents

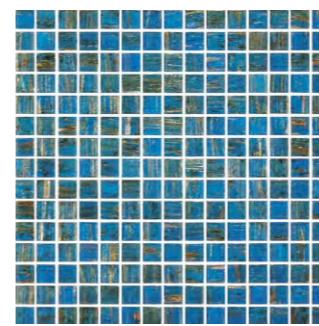

**MONTE CRISTO** | GW-MOCMOSPF  
327 x 327 x 4mm

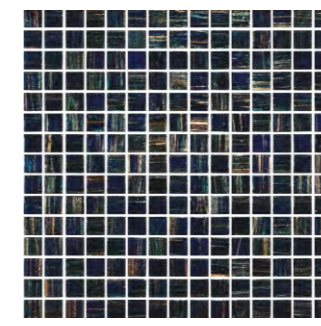

**MAGALIA** | GW-MAGMOSPF  
327 x 327 x 4mm

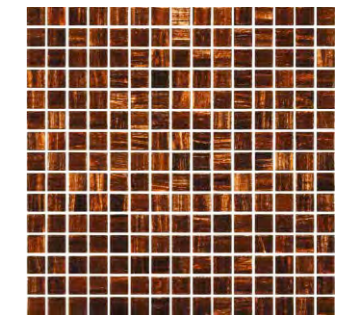

**KLONDIKE** | GW-KLOMOSPF  
327 x 327 x 4mm

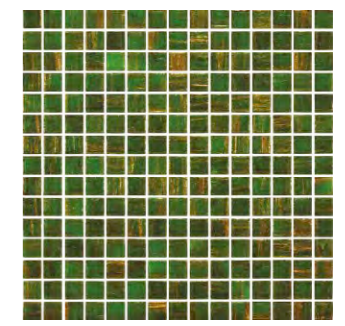

**SEQUOIA** | GW-SEQMOSPF  
327 x 327 x 4mm

# Poolside

life on the edge

attractive, hardwearing and slip-resistant tiles and  
mouldings for pool and spa surround areas



# Dorset Woolliscroft

High performance safety floor tiles in a choice of textured finishes and co-ordinating colours, plus a full range of fittings and finishing pieces.

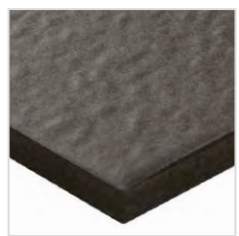

**Textured**  
300mm



**TEXTURED STEEL GREY**  
DW-TXSGR3030 300 x 300 x 9mm  
Barefoot Wet (TRRL55 Wet) = 47



**TEXTURED QUARTZ**  
DW-TXQUZ3030 300 x 300 x 9mm  
Barefoot Wet (TRRL55 Wet) = 47

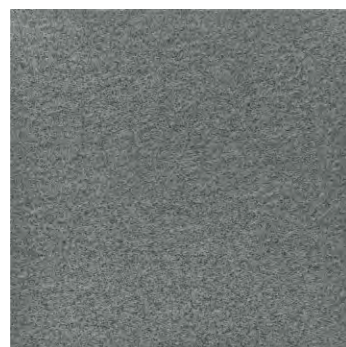

**TEXTURED DARK GREY**  
DW-TXDGR3030 300 x 300 x 9mm  
Barefoot Wet (TRRL55 Wet) = 47



▲ Textured Quartz

With a lightly rippled finish, Textured is great for reception areas, corridors, changing rooms and toilets



**Pinhead**  
148mm

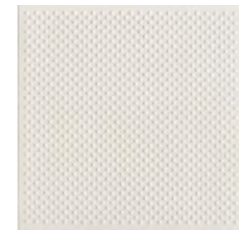

**PINHEAD WHITE**  
DW-PHWHT1515 148 x 148 x 9mm  
Barefoot Wet (TRRL55 Wet) = 48



**PINHEAD STEEL GREY**  
DW-PHSGR1515 148 x 148 x 9mm  
Barefoot Wet (TRRL55 Wet) = 48

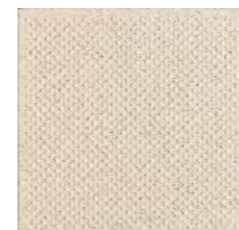

**PINHEAD QUARTZ**  
DW-PHQZ1515 148 x 148 x 9mm  
Barefoot Wet (TRRL55 Wet) = 48



**PINHEAD DARK GREY**  
DW-PHDGR1515 148 x 148 x 9mm  
Barefoot Wet (TRRL55 Wet) = 48



**PINHEAD STONE**  
DW-PHSTO1515 148 x 148 x 9mm  
Barefoot Wet (TRRL55 Wet) = 48

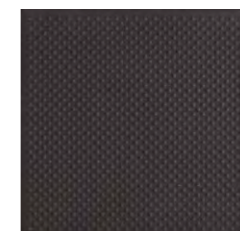

**PINHEAD BLACK**  
DW-PHBLK1515 148 x 148 x 9mm  
Barefoot Wet (TRRL55 Wet) = 48

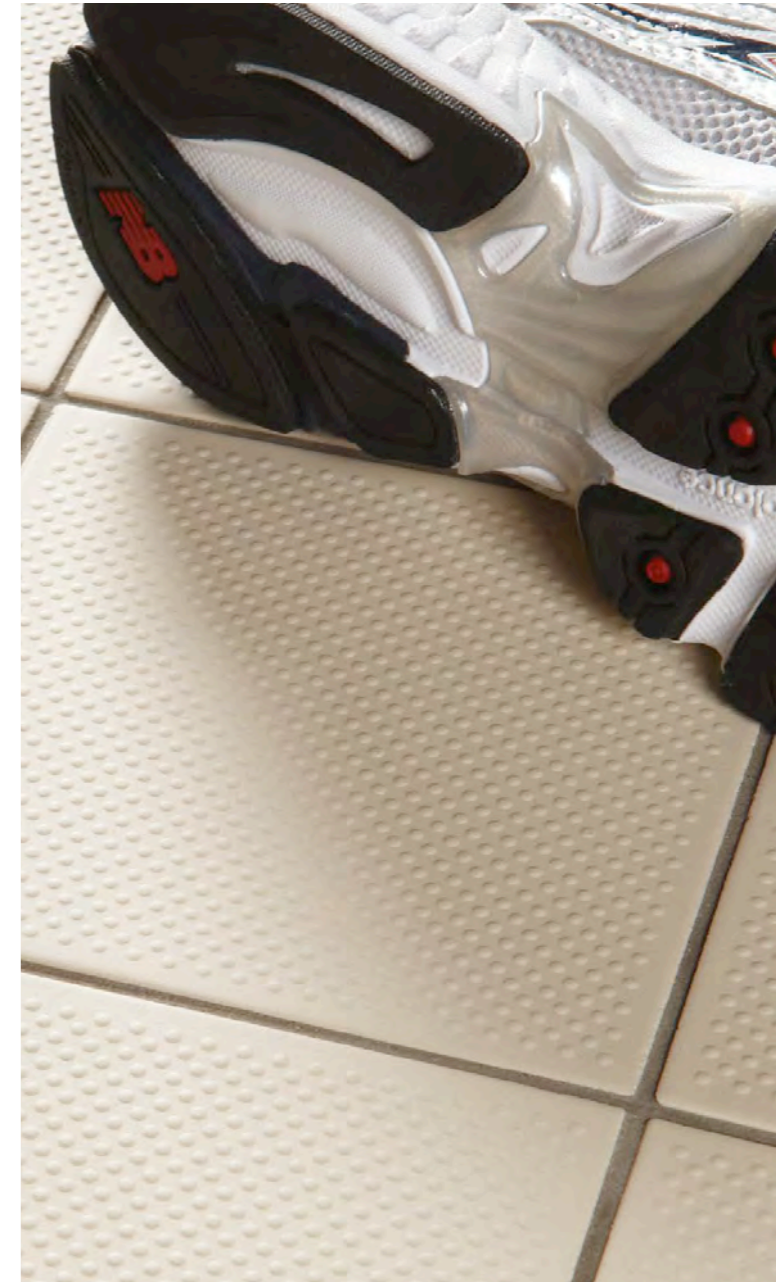

▲ Pinhead White

With high volume displacement properties, this pimpled finish is good for slip-resistance in barefoot wet areas

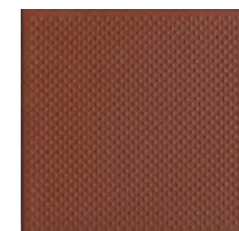

**PINHEAD RED**  
DW-PHRED1515 148 x 148 x 9mm  
Barefoot Wet (TRRL55 Wet) = 48







**Luna**  
148mm & 300mm

The softly textured structure is excellent for barefoot wet areas such as pool surrounds and showers.

Suitable for use on sloping areas and access ramps.



**LUNA WHITE**  
DW-LUWHT1515 148 x 148 x 9mm  
DW-LUWHT3030 300 x 300 x 9mm  
Barefoot Wet (TRRL55 Wet) = 48



**LUNA QUARTZ**  
DW-LUQUZ1515 148 x 148 x 9mm  
DW-LUQUZ3030 300 x 300 x 9mm  
Barefoot Wet (TRRL55 Wet) = 48



**LUNA STEEL GREY**  
DW-LUSGR1515 148 x 148 x 9mm  
DW-LUSGR3030 300 x 300 x 9mm  
Barefoot Wet (TRRL55 Wet) = 48



**LUNA DARK GREY**  
DW-LUDGR1515 148 x 148 x 9mm  
DW-LUDGR3030 300 x 300 x 9mm  
Barefoot Wet (TRRL55 Wet) = 48





Tetra Steel Grey and Dark Grey 300mm with Black Pool Grip (page 37) ▲



▲ Multidisc Dark Grey with Quartz Channels and Dark Grey Coving (page 36)



## Tetra 148mm & 300mm

The clever polygon structured finish provides great liquid displacement and a sure grip



**TETRA WHITE**  
DW-TEWHT1515 148 x 148 x 9mm  
Barefoot Wet (TRRL55 Wet) = 42



**TETRA STEEL GREY**  
DW-TESGR1515 148 x 148 x 9mm  
DW-TESGR3030 300 x 300 x 9mm  
Barefoot Wet (TRRL55 Wet) = 42



**TETRA QUARTZ**  
DW-TEQUZ1515 148 x 148 x 9mm  
DW-TEQUZ3030 300 x 300 x 9mm  
Barefoot Wet (TRRL55 Wet) = 42

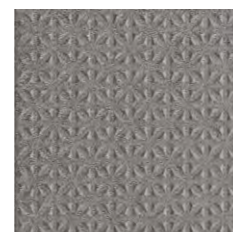

**TETRA DARK GREY**  
DW-TEDGR1515 148 x 148 x 9mm  
DW-TEDGR3030 300 x 300 x 9mm  
Barefoot Wet (TRRL55 Wet) = 42



2 size options



## Multidisc 148mm

The softly contoured spot finish is comfortable underfoot for shower rooms and changing areas

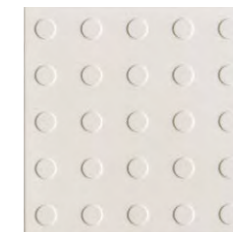

**MULTIDISC WHITE**  
DW-MDWHT1515 148 x 148 x 9mm  
Barefoot Wet (TRRL55 Wet) = 44

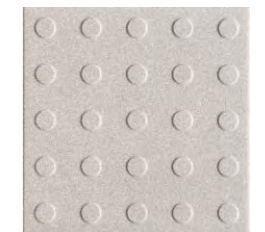

**MULTIDISC STEEL GREY**  
DW-MDSGR1515 148 x 148 x 9mm  
Barefoot Wet (TRRL55 Wet) = 44



**MULTIDISC QUARTZ**  
DW-MDQUZ1515 148 x 148 x 9mm  
Barefoot Wet (TRRL55 Wet) = 44

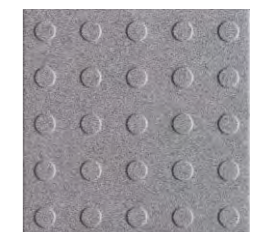

**MULTIDISC DARK GREY**  
DW-MDDGR1515 148 x 148 x 9mm  
Barefoot Wet (TRRL55 Wet) = 44

# Dorset Woolliscroft Fittings

For an impeccable finish and optimum performance, these fittings are designed to co-ordinate perfectly with the Dorset Woolliscroft floor tile range.

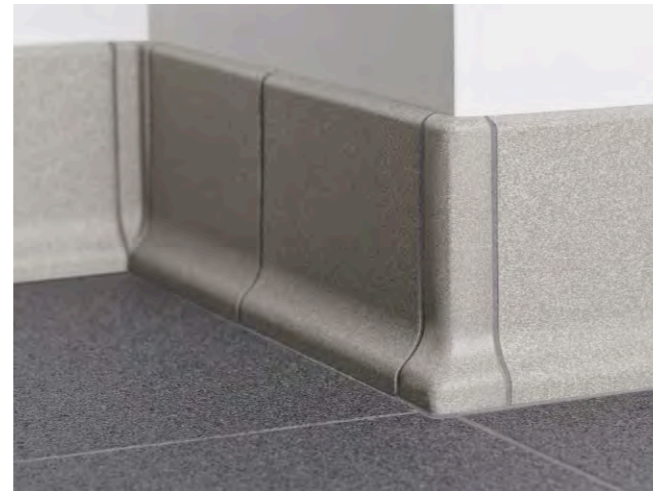

▲ Coving with Internal and External Angles in Steel Grey

## Coving



- Provides a fully integrated finish
- Reduces 'dirt traps' in corners and at wall and floor transitions
- Hygienic and easy to clean
- Protects walls from footwear scuffs and potential damage from cleaning equipment
- Mount over, or flush with, wall and floor tiles

## Step tread

- 12mm thick for extra durability
- Grooved profile for grip
- Bullnosed edge for comfort and safety
- Provides visual warning of surface edges
- Suitable for use as a pool grip



## Pool grip

148 x 109 x 9mm

- Ergonomic finger-grip profile

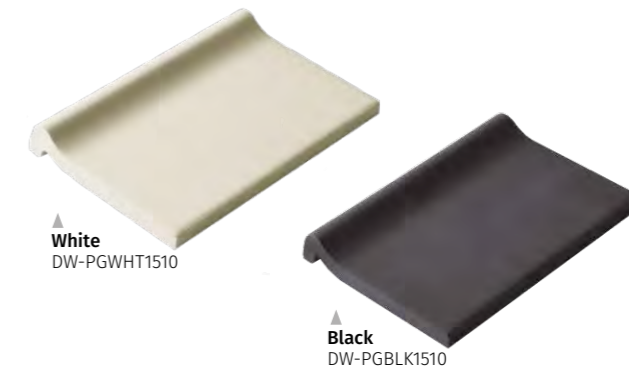

## Channels

- Ergonomic 'foot friendly' form factor
- Effective drainage

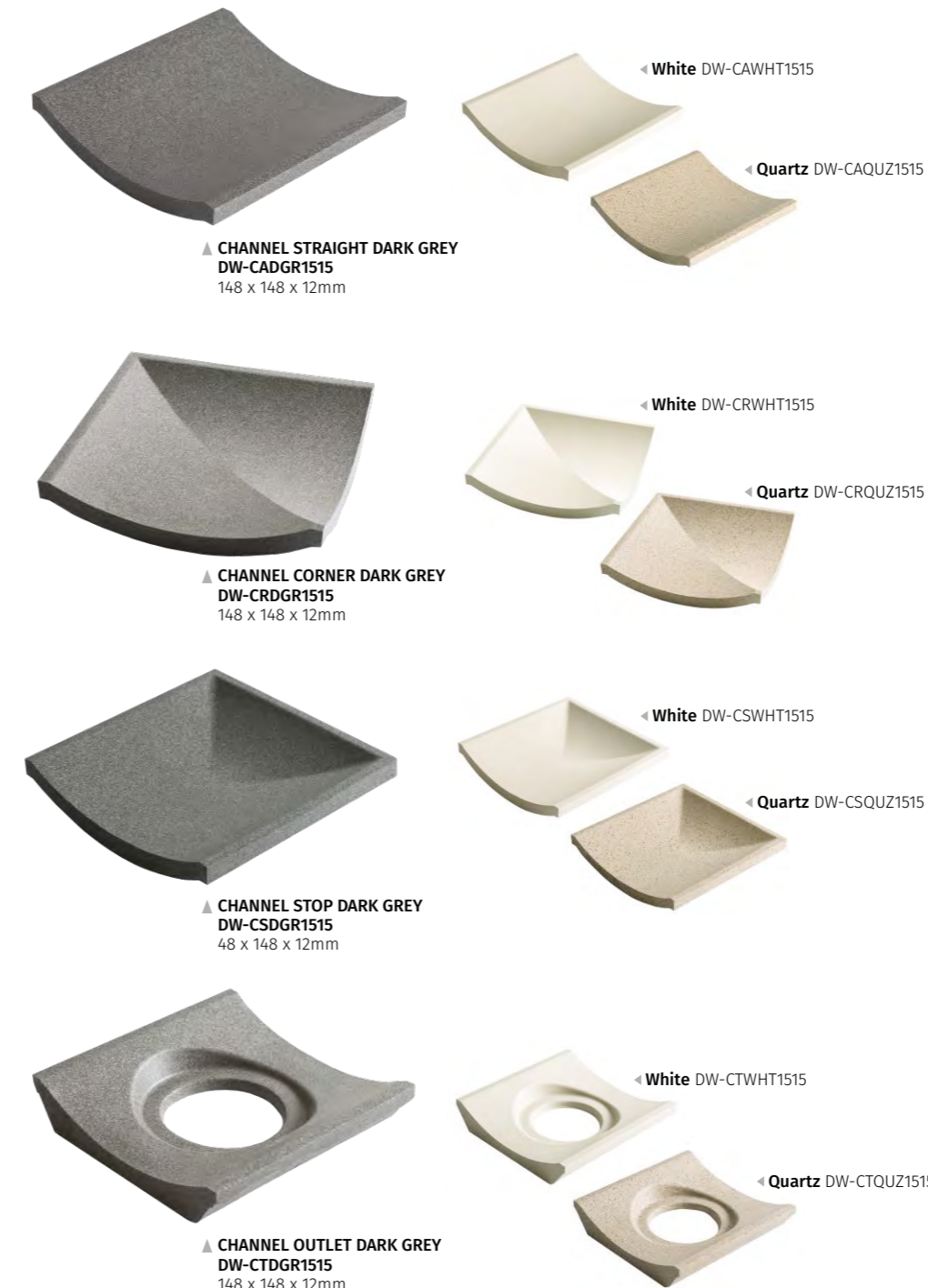

All products are fully vitrified, making them frost proof and suitable for external use

Nominal dimensions are stated, which are subject to slight variation within internationally accepted standards

Where applicable, tiles conform to BS EN 14411 2016

Full test results are available at [www.dorsetwoolliscroft.com](http://www.dorsetwoolliscroft.com)

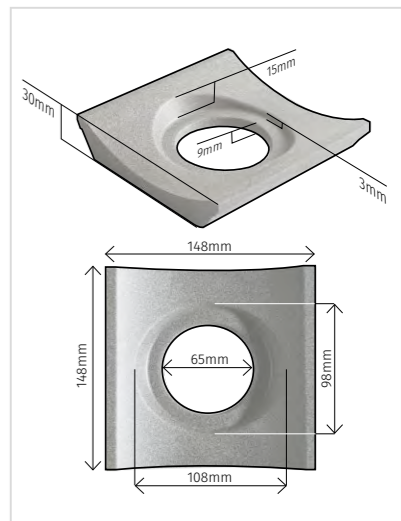



◀ Far left: Carvalo Textured Slip Resistant (floor) & Carvalo Natural (wall)  
 ▶ Sandalo Enea Slip Resistant

# Wood Effect

The beauty of natural wood with the durability and practicality of porcelain.  
 Matt glazed tiles with floor and wall suitable options

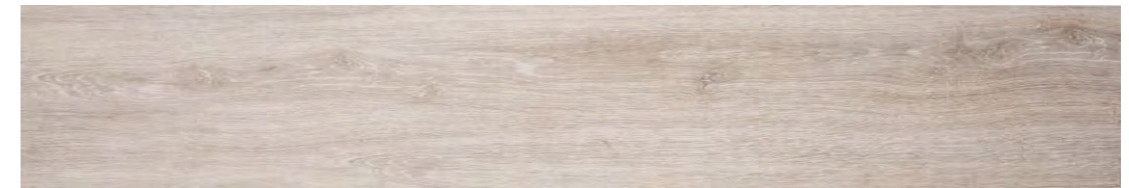

**ALAMO ASH SLIP RESISTANT**  
 CS1932-12020 1200 x 200 x 11mm  
 Barefoot Wet (TRRL55 Wet) = 65



**ALAMO ASH**  
 CS1931-12020 1200 x 200 x 11mm



**ALAMO NATURAL SLIP RESISTANT**  
 CS1934-12020 1200 x 200 x 11mm  
 Barefoot Wet (TRRL55 Wet) = 65



**ALAMO NATURAL**  
 CS1933-12020 1200 x 200 x 11mm

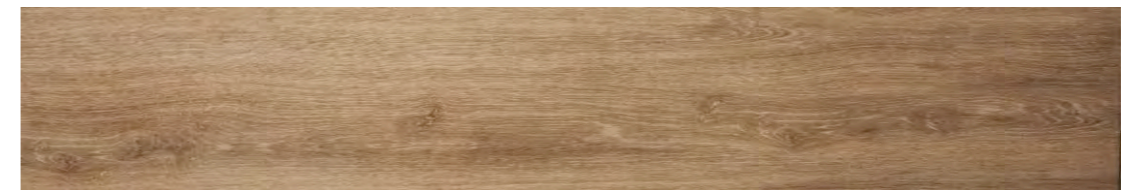

**SANDALO ENEA SLIP RESISTANT**  
 CS1936-12020 1200 x 200 x 11mm  
 Barefoot Wet (TRRL55 Wet) = 65



**SANDALO ENEA**  
 CS1935-12020 1200 x 200 x 11mm



**CARVALO TEXTURED SLIP RESISTANT**  
 CS1052-12020 1169 x 190 x 11mm  
 Barefoot Wet (TRRL55 Wet) = 45



**CARVALO NATURAL**  
 CS1051-12020 1169 x 190 x 11mm

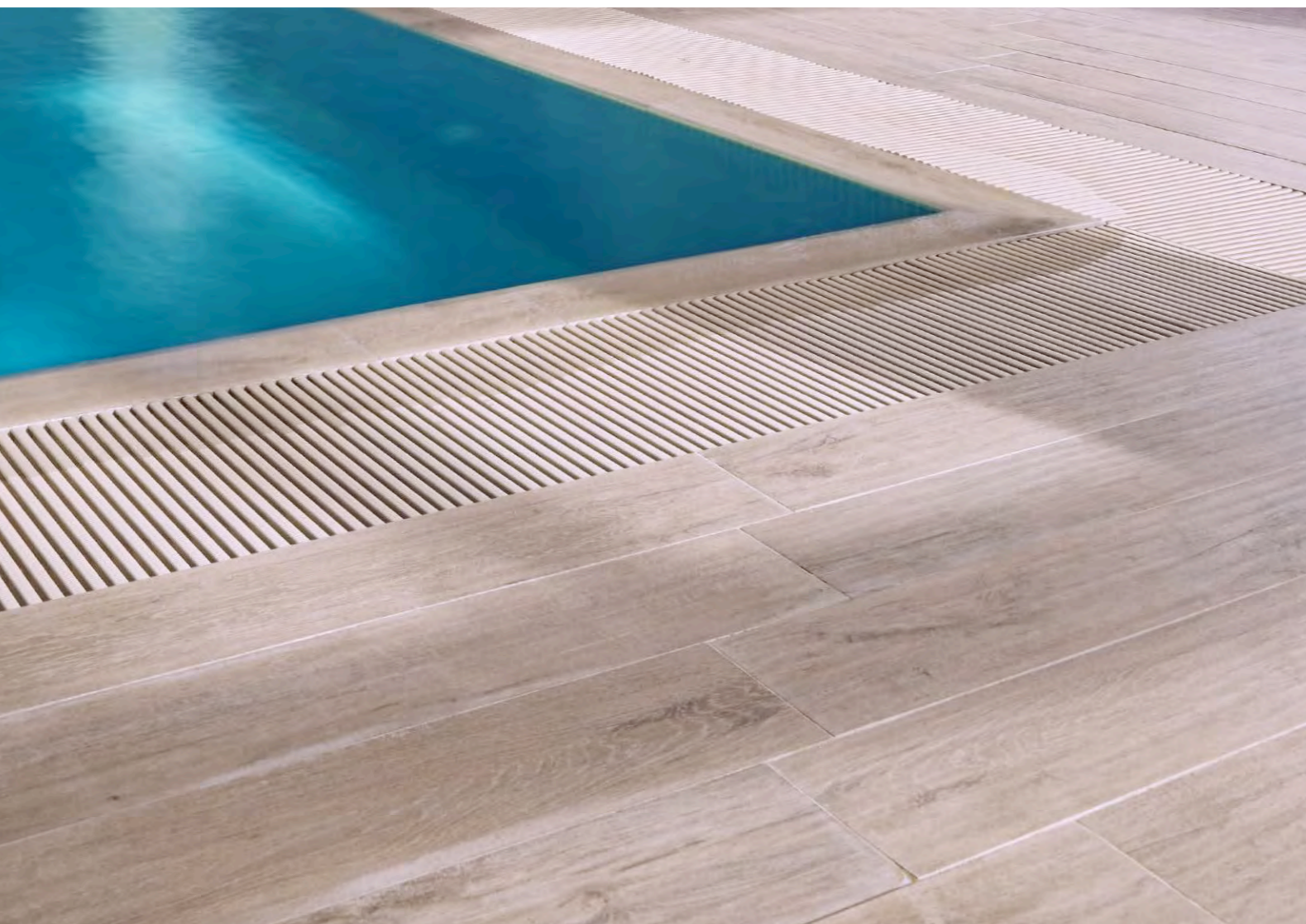

◀ Alamo Ash Slip Resistant



Grey ▲

# Savana

Includes a larger format for large spaces

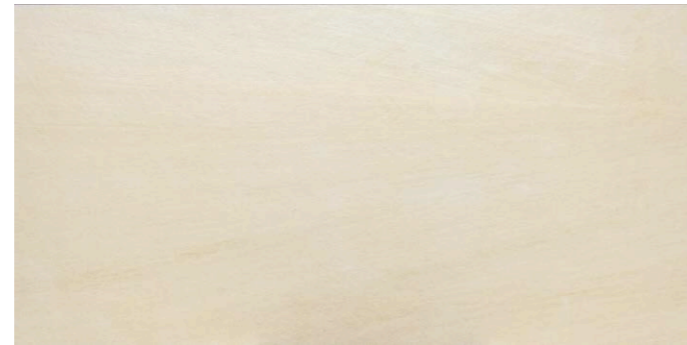

**IVORY SLIP RESISTANT**  
**CB35-003-6030** 600 x 350 x 9mm  
**CB35-003-9045** 900 x 450 x 9mm

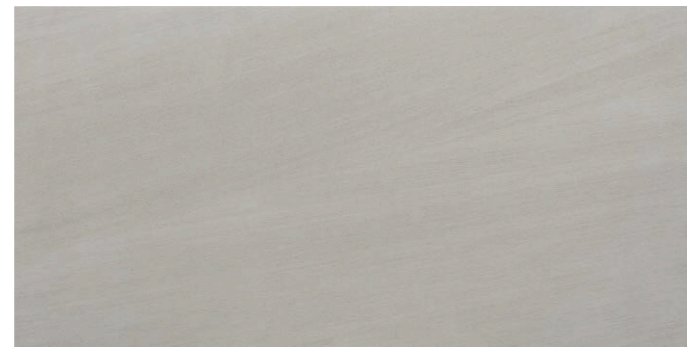

**GREY SLIP RESISTANT**  
**CB35-001-6030** 600 x 350 x 9mm  
**CB35-001-9045** 900 x 450 x 9mm

In this range:

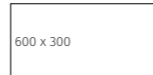

# Soft Earth

Three subtle shades and 600 x 300mm format makes Soft Earth a versatile range

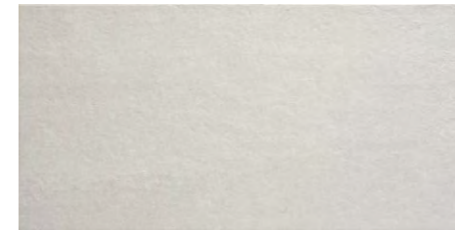

**WHITE SLIP RESISTANT**  
**CB35-011-6030** 600 x 300 x 9mm

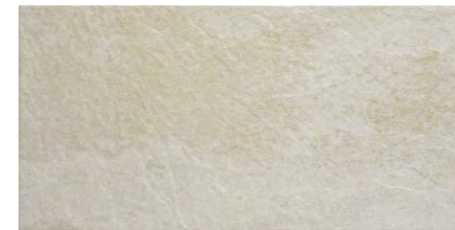

**IVORY SLIP RESISTANT**  
**CB35-013-6030** 600 x 300 x 9mm

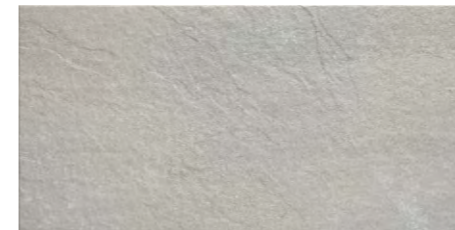

**GREY SLIP RESISTANT**  
**CB35-016-6030** 600 x 300 x 9mm



▲ Ivory (floor)



# Slate Chiara

Glazed porcelain with a convincing natural stone appearance

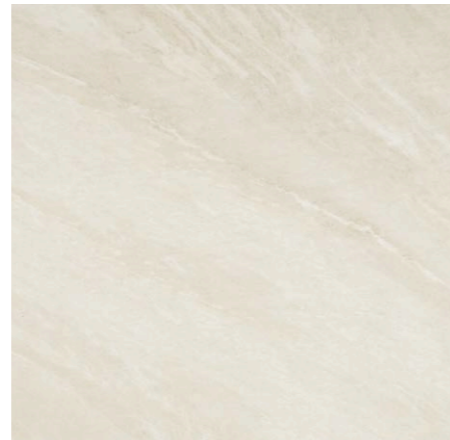

**SLATE CHIARA BIANCO PORCELAIN SLIP RESISTANT**  
 CS765-6060 605 x 605 x 10mm  
 Barefoot Wet (TRRL55 Wet) = 48



# Broadway Lime

A versatile large concrete-effect tile.



**BROADWAY LIME STRUCTURED (SLIP RESISTANT)**  
 CS1132-6060 600 x 600 x 10mm  
 Barefoot Wet (TRRL55 Wet) = 59



# Looking for more?

This **Essentials Collection** includes all the mosaics, tiles and fixing materials you need for a huge range of different pools, poolside areas and spas.

Contact us by phone or email if you would like more information or can't find the products you are looking for.

SHOWROOM: 91 St. John Street, London EC1M 4NU tel: 0203 751 2235  
 HQ: Falcon Road, Exeter, EX2 7LF tel: 01392 473037 fax: 01392 473035  
 info@designworkstiles.com / www.designworkstiles.com

Ask us if you would like your copy of our inspirational look book **Ultimate Pool & Spa**



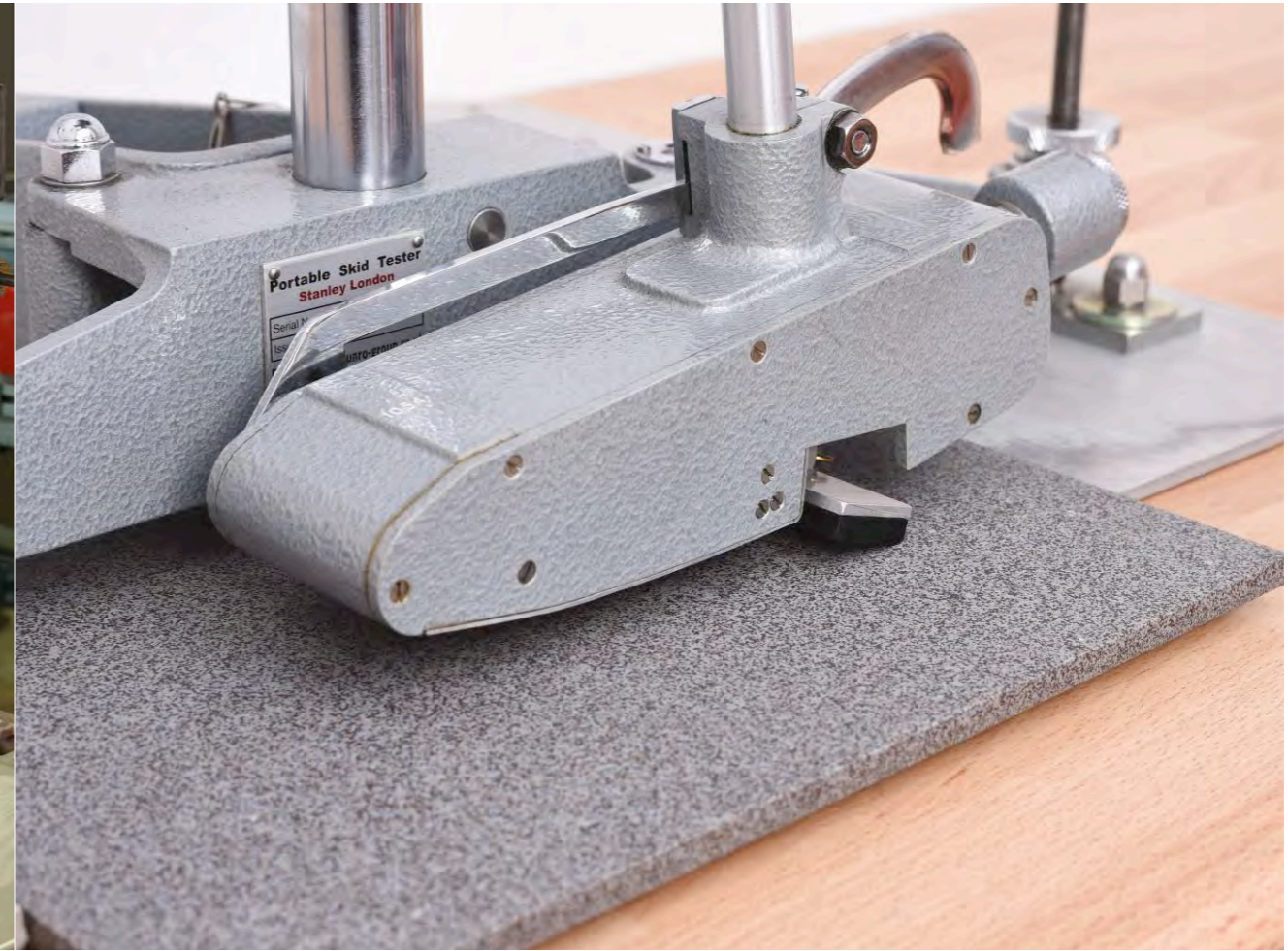

## home ground to perfection

Skirting, bullnosing and gradino profiles can all be shaped in-house, offering you a fully integrated look

There's no need to compromise on finishing pieces such as bullnose edging, gradino profiles and skirtings, as you can choose these at the same time and from the same tiles as your pool surrounds. We engineer these pieces at our in-house facilities from our extensive stock to your specific installation requirements.

## safety first

All tiling products used for flooring need to meet specific criteria. Our products have passed the tests

There is a duty of care upon all flooring designers, manufacturers, distributors, installers, contractors and on the architects who specify flooring to ensure that flooring surfaces are fit for purpose and meet the Health and Safety Executive's guidelines for slip resistance.

Our products are tested for slip resistance and other properties using a range of methods and the results are included next to each floor product in the pages of this brochure. The pendulum test is carried out on our premises by our technical advisor, to determine the barefoot wet co-efficient of friction using a TRRL55 rubber slider.

**Sample Service**  
Samples and story boards are available on request.

**Dimensions**  
Nominal sizes and thicknesses are shown throughout the brochure. All dimensions are subject to a tolerance of ± 2.5mm. When calculating the number of mosaic sheets you will require, please do not forget to make 5% allowance for cutting and wastage.

**Colour Variations**  
There may be distinctive yet subtle variations in shade in many of the mosaics and tiles included in this brochure. A single sample tile should not be taken as a completely accurate indication of colour.

**Adhesives and Grouts**  
The water in your pool must have a pH balance of between 7.2 and 8 to eliminate acid and high alkali attacking the grout, which can cause the tiles to debond. Please be aware that all grouts have different water absorption properties. We recommend that your grout should be between 0.05% and 0.1% water absorption. Some grouts can have up to 7% water absorption, which is likely to affect the adhesion and cause the tiles to debond. Always follow the manufacturers' instructions.

**Caution**  
Coloured grouts may be used on our mosaics, however, they may alter the overall appearance of the mosaic colour. If they are used, we strongly recommend that a small area is tested before installation. Please be aware that certain grouts are not UV resistant and will fade when placed in direct sunlight. Please contact the grout manufacturer for further advice. When installing mosaics alongside thicker tiles that are not in pools, e.g. as a border, we recommend a packing material such as P.C.I. Peditur boards.

**Pools and Power Showers**  
If using our tiles within a pool that has water movement e.g. flumes and slides, or if using in a shower area which has a power shower, it is important to use adhesive and grout products specified for the purpose. For further advice please contact us.

NB Original Style makes no representations as to the fitness for purpose of third party adhesives and grouts.

**Glass Mosaics - Maintenance and Cleaning**  
Please note, the use of certain acid based cleaning products may cause some mosaics to react and change in character. Do not use hydrofluoric acid pool cleaners as these will have an adverse effect on the mosaics. We recommend the use of pH neutral cleaning products on our tiles unless stated otherwise. Regular cleaning of mosaics is recommended as a build up of certain deposits (such as magnesium and calcium) can be detrimental, even causing acid etching on the surface. These are difficult or, in some cases, impossible to remove if left.

**Glass Mosaics - Scratching**  
As with all glass products, glass mosaics can be scratched. Care should be taken in installation and that glass mosaics are not put in high-risk areas for scratching. It is important to use a fine grade or non-sanded grout to avoid scratching the surface of glass mosaics. Glass mosaics should not be used on counter tops because of the likelihood of scratching.

**Glass Mosaics - Use Near Heat Sources**  
Original Style recommends mosaics are installed a minimum of 3cm from any direct heat source. As glass is a very good conductor of heat caution must be taken when considering installation in areas of extreme heat.

**Storage**  
It is important to keep all Original Style tiles and also any fixing materials such as grouts and adhesives in a cool and dry area before installation.

**Photography**  
Owing to variations in studio lighting and printing inks, the tile colours shown in this brochure may differ slightly from those of the actual tiles. Before making your choice it is always advisable to ask for samples.

**Product Specific Information**

**Gold Fleck and Iridescent Mosaics**  
The surfaces of some of the gold fleck and iridescent mosaics are very slightly pitted, which is one of their inherent features. Unless they are sealed first, any pitted surface may become unavoidably filled during the grouting process, resulting in a speckled appearance. We recommend that these tiles are sealed with a removable protective sealer prior to installation.

Please test a small inconspicuous area before installation, following all manufacturers' instructions.

**Slip Resistance testing methods**  
Pendulum Barefoot Wet (BS7976-2 TRRL 55)

This is a swinging arm test apparatus to determine the wet coefficient of friction using a rubber slider that simulates a bare foot in wet conditions.

Accepted limits for flooring using this technique are as follows:

Slip Potential	Range
High	19 and below
Moderate	20 to 39
Low	40 to 74
Very Low	75 and above

**Limits of Liability**  
Original Style accepts no liability for the faulty installation of its tiles. In the case of any claim relating to the tiles themselves, Original Style's liability, to the extent permitted by law, is limited to either the replacement of the product or a refund of the cost of the product, and does not extend to cover any consequential loss. Tiles must be inspected prior to installation and claims cannot be considered after the tiles have been installed. Claims must be reported within seven working days from receipt of the tiles. Tile sizes may vary slightly from the stated nominal dimensions within internationally accepted standards. Please be advised that installation constitutes acceptance of the quality, colour, texture, size and shade of the tiles. Please note the use of certain acid-based cleaning products may cause some of the tiles to react and change in character. Original Style warrants that its tiles conform to their description and are fit for their purpose. Original Style makes no representations as to the fitness for purpose of third party adhesives and grouts.

Original Style makes no other express or implied warranty as to fitness or suitability of the products for particular installations. We extend no guarantees, express or implied, as to wear resistance or maintenance procedures.

To make sure of a quality installation, you'll need specific adhesives, grouts and waterproofing from the specialists. Here is a selection of products that can be used for pools and spas

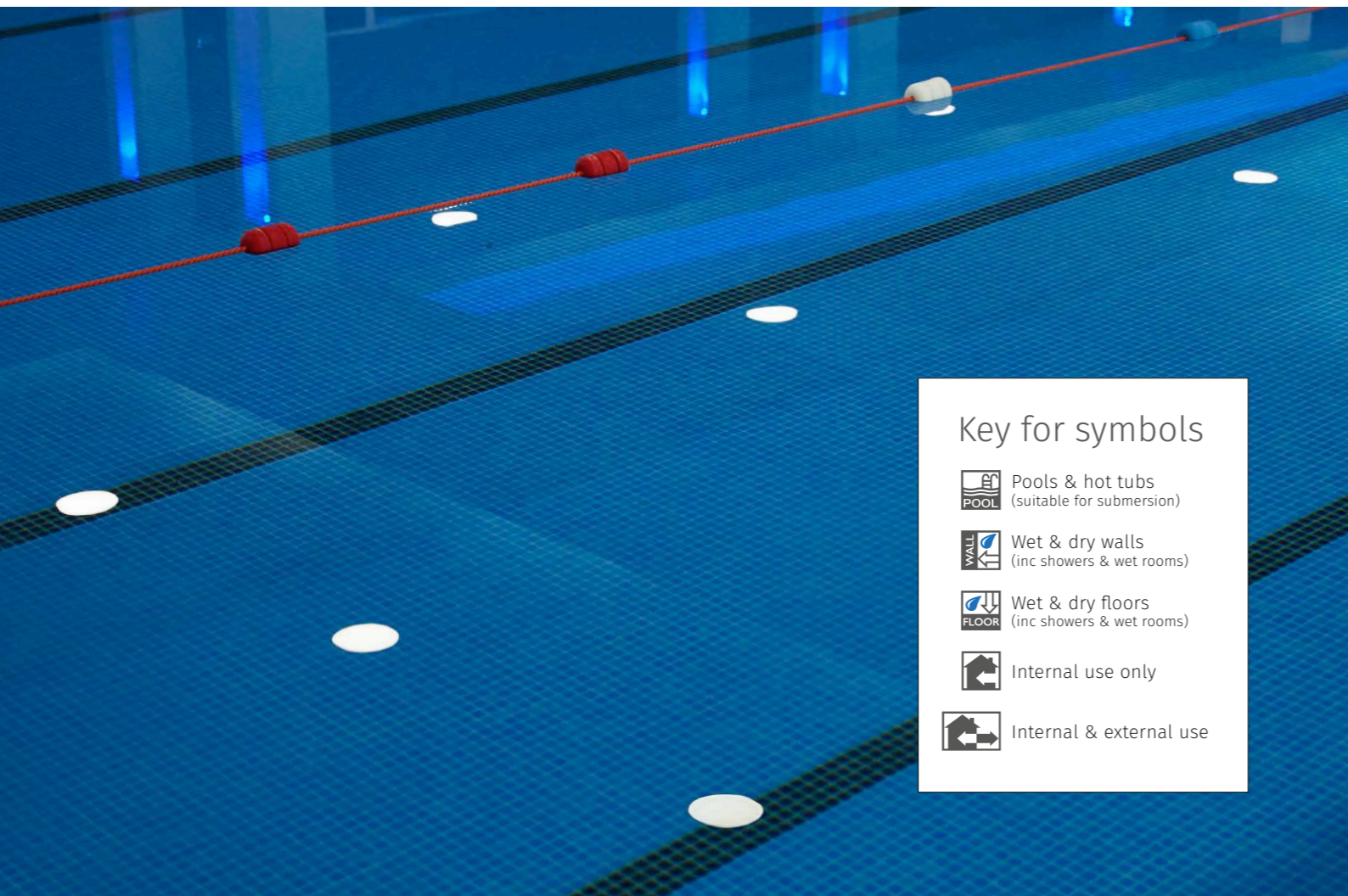

**Key for symbols**

- Pools & hot tubs (suitable for submersion)
- Wet & dry walls (inc showers & wet rooms)
- Wet & dry floors (inc showers & wet rooms)
- Internal use only
- Internal & external use







**SHOWROOM:** 91 St. John Street, London EC1M 4NU tel: 0203 751 2235  
**HQ:** Falcon Road, Exeter, EX2 7LF tel: 01392 473037 fax: 01392 473035  
info@designworkstiles.com / www.designworkstiles.com



The 'Designworks' logo is a registered trade mark of Original Style Ltd.  
Original Style Limited is registered in England number 3018117.  
Registered Office: Falcon Road, Sowton Industrial Estate,  
Exeter, Devon, England EX2 7LF

DWESPOOL1  
©Designworks Tiles 2018