

designworks:tiles

ULTIMATE
POOL & SPA

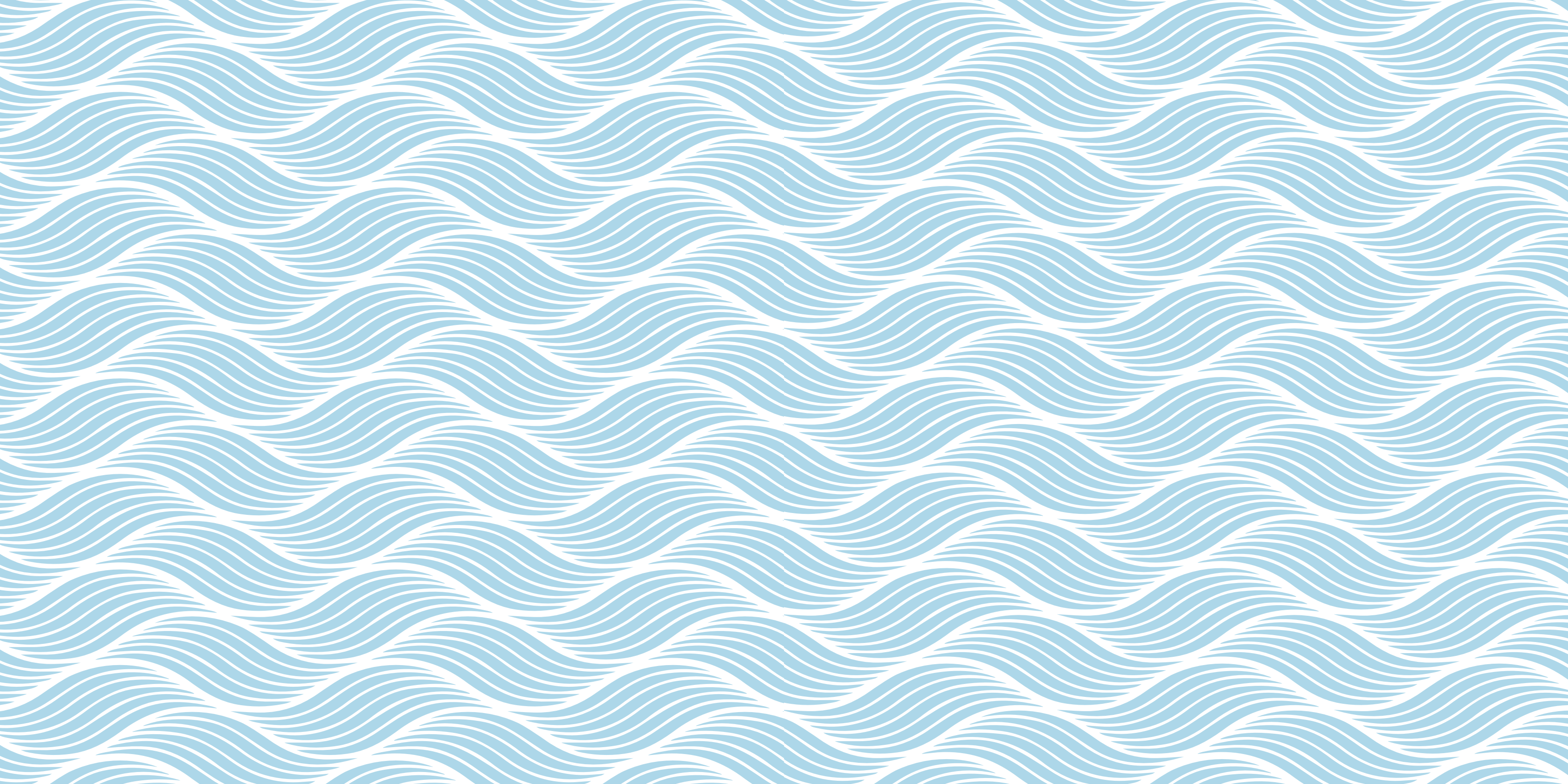

ULTIMATE POOL & SPA

Are we being shameless by calling this the ultimate collection of tiles for pools and spas? Although it is, in our opinion, our best selection yet of pool and poolside suitable products. But one of the vital elements is missing – your design. Your vision. The list of wants and needs translated into that pool of dreams.

The following pages are here to inspire, inform and guide you. But it's only together can we achieve the shining, shimmering, watery thing of beauty that will become the ultimate pool and spa.

“Water does not resist. Water flows. When you plunge your hand into it, all you feel is a caress.”

Margaret Atwood, writer



Contents

Introduction	08-11
Inspiration	12-23
Pool Mosaics	24-69
Poolside and Spa	70-101
Feature Walls	104-133
Details	135
Safety	137
Important Information	138
Get in touch	139

Pools Past, Present and Future

The Great Bath at Mohenjo-Daro, Pakistan (in the Indus Valley) is the oldest known swimming pool in the world, probably built around the 3rd Millennium BC. To put that into context, that's the Bronze Age. Pyramids were being built in Egypt. The Great Pool (now an ancient monument) was for special religious functions where water was used to purify and renew. At 12 x 7 metres and 2.4 metres deep, it had two staircases, a brick floor and was filled by rainwater. Several centuries on, and the Romans were taking their bathing seriously too. Heated baths, cold plunge pools, treatments and areas for socialising were key structures in their villas and towns.

In the twenty first century swimming pools are built to fulfil many different functions: health, exercise, sport, relaxation, status, privacy, luxury, family fun, therapy, investment in a property. There are so many different formats too, from naturalistic ponds to roof top infinity pools. The choice is vast, the options almost endless.

What does the future hold? Your guess is as good as ours... wellbeing and health will probably be even more important than now, advances in technology and automation could revolutionise the use of materials and resources.

“Nothing is softer or more flexible than water, yet nothing can resist it.”

Lao Tzu, Chinese philosopher



Why does my pool look blue?

Look at a glass of tap water and it is clear and colourless. And yet the water in pools and the sea appear to be shades of blue. Why?

It's all about the light. Sunlight is a spectrum of colours, through the rainbow from red to violet. When the light hits an object, some of the colours will be absorbed and some scattered. For example, an apple looks red because it absorbs all the other colours in the light and scatters only red. Water absorbs different wavelengths of sunlight to different degrees, with the longest wavelengths with the lowest energy being absorbed first. Red is the quickest to be absorbed, then orange then yellow. The blue end of the spectrum travels further through water before being absorbed. The colours disappear underwater in the same order.

The sea seems to be blue because it absorbs all the other colours and only the blue light is scattered or reflected. A glass of water is too small an amount for the reflection of the blue light to be obvious, but when you fill a white bath with water you will see a blue tint. Clean water always appears blue, and deeper water appears more deeply blue as more of the other colours of the spectrum are absorbed.

At what depth underwater do colours disappear?

Red	4.6m
Orange	7.6m
Yellow	10.7m – 13.7m
Green	21.3m – 22.8m

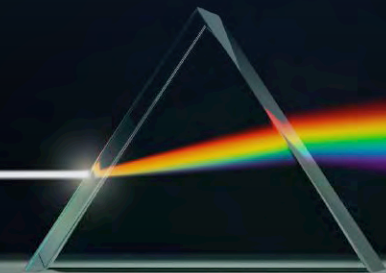

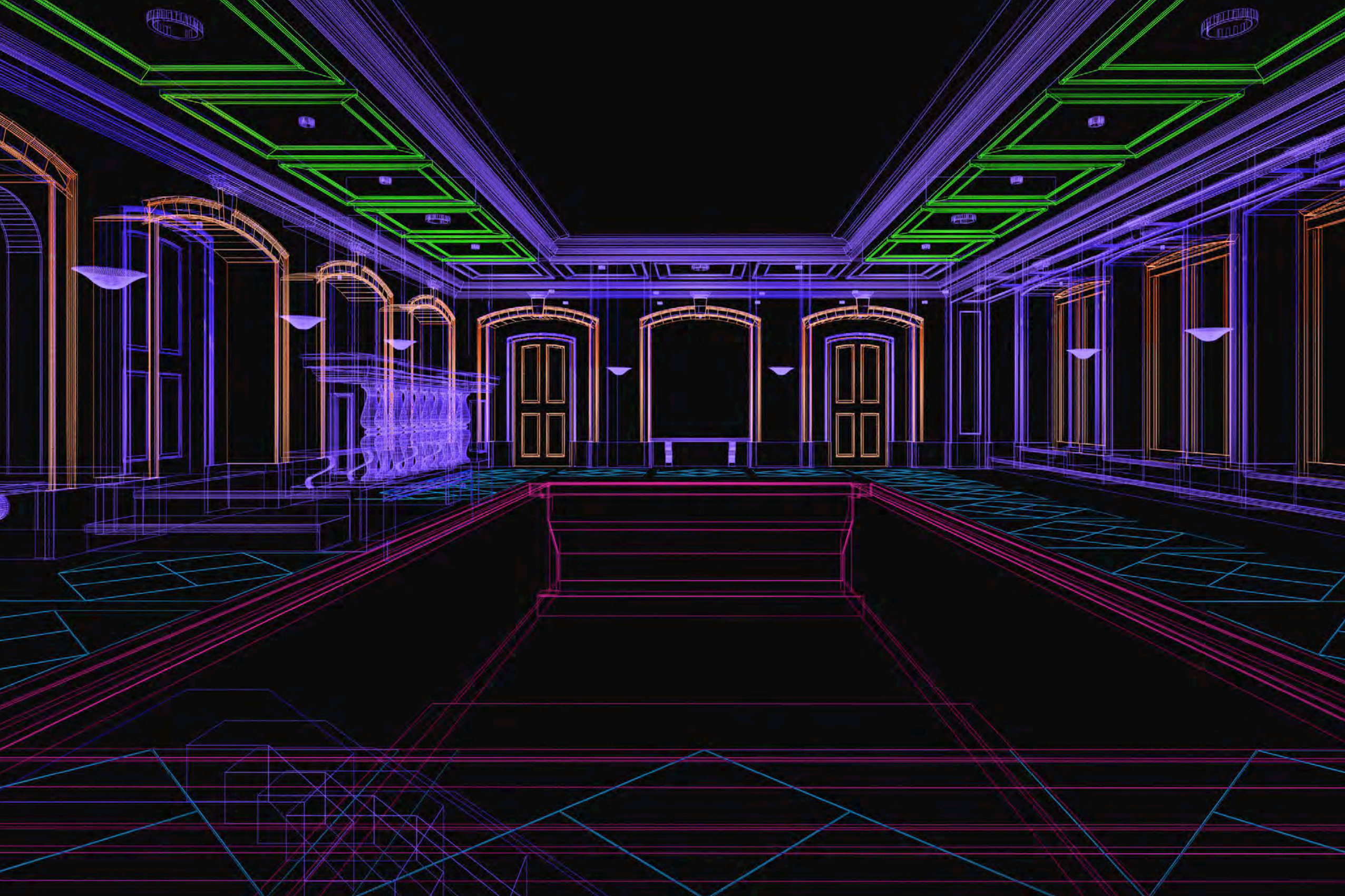

You can have anything you want ...

(well, within reason). Bring along your ideas, your lists of likes and dislikes. Your favourite colours and textures. If you're a creative type, why not put a mood board together? Or if not, a sketch on the back of an envelope will do. Tell us what you really really want out of your pool. We can provide the technical help and guidance on what's possible, safe and legal. And we can create incredibly realistic computer generated images (renders) to visualise just how your pool will look.

"Everything you can imagine is real."
Pablo Picasso

Why do you want a pool?

“If there is magic on this planet, it is contained in water.”

Loran Eisely, anthropologist

As humans we have always been drawn to the magic of water. Our ancient ancestors had to seek out water to survive. Even now we are unconsciously drawn to glossy objects, with recent research with adults and young children testing the hypotheses that the preference for glossy surfaces stems from an innate preference for fresh water as a valuable resource. Your desire for a pool simply shows how in tune you are with our universal human needs.



Inspiration





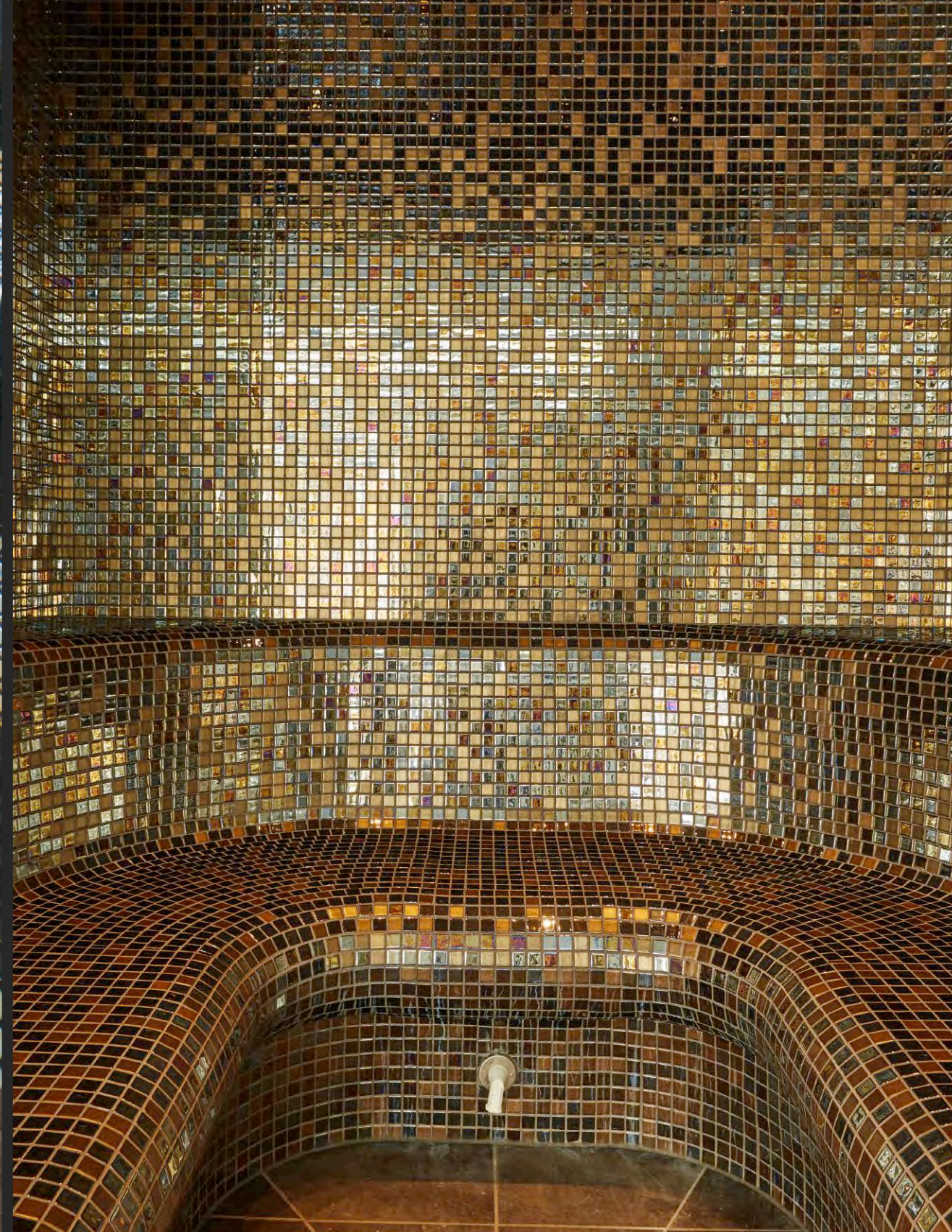
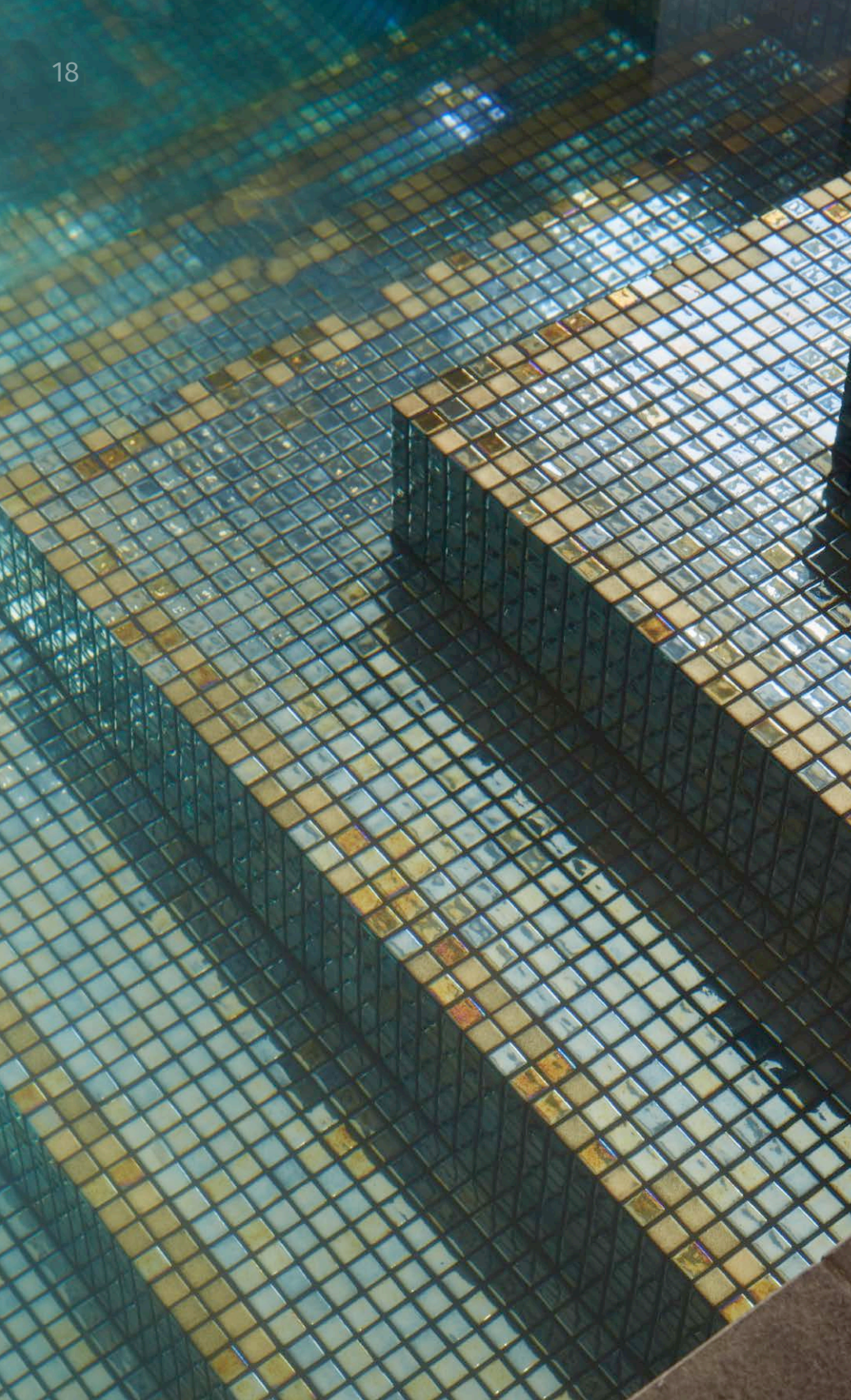



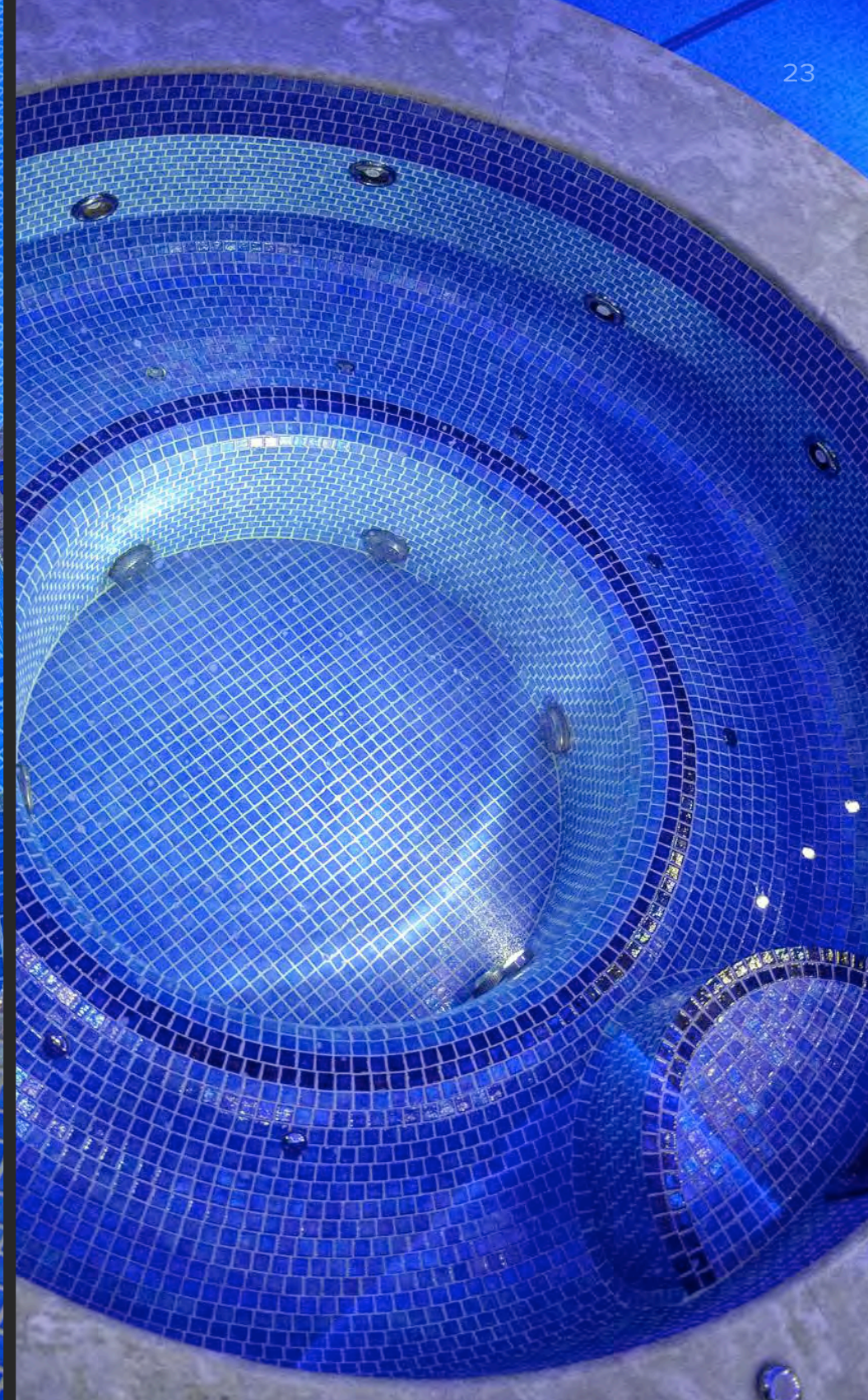

Glass mosaics are the obvious choice for lining a pool. They're practical because the small chips of glass are joined together on the back with silicone dots and are flexible to install, so curves and irregular surfaces don't pose problems (see section on JointPoint® page 65. Other options are paper faced, see pages 68-69). Mosaics are easy to keep clean and fresh looking. They are safe when needed if you go for the slip resistant and Safe Step options (page 56-64). They're versatile because you can mix and match – and there is so much choice...

POOL MOSAICS





Cocktails 25mm

A range of glorious mosaics named after famous cocktails. Like their namesakes, they have been skillfully blended to suit different tastes and moods. With rich colours and shimmering effects, the Cocktail collection is intoxicating both above and below the water line.

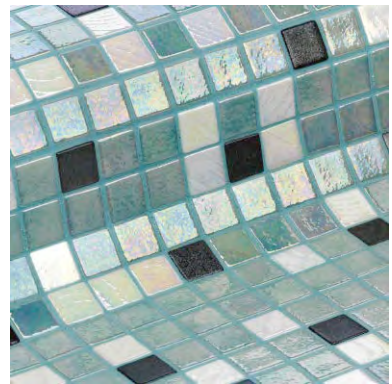

Caipirinha
SM-CPRHMOS

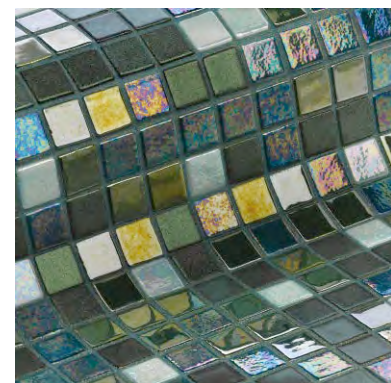

Tomahawk
SM-TMHKMOS

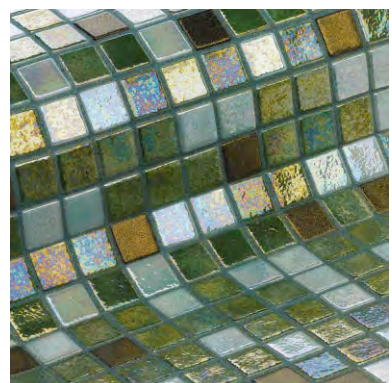

Grasshopper
SM-GRASHMOS

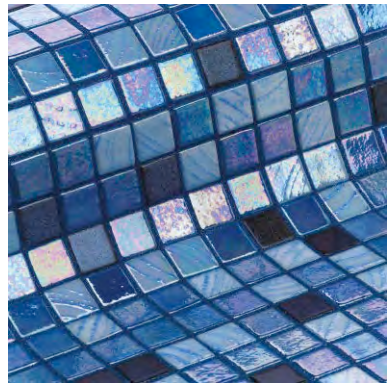

Long Island
SM-LNISMOS

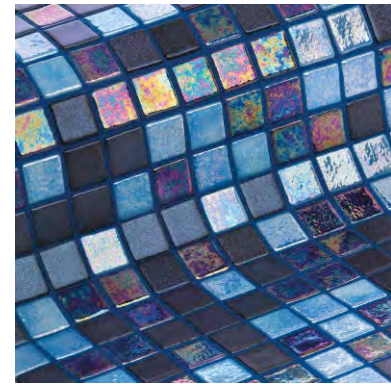

Blue Lagoon
SM-BLLAMOS

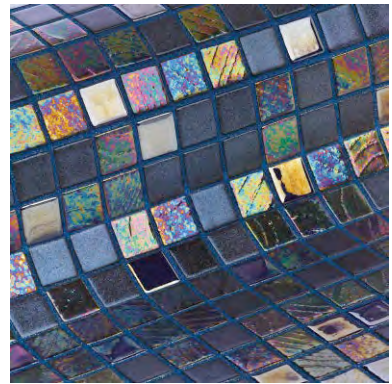

Blue Moon
SM-BLMNMOS

All mosaics on this page are on a two week lead time

Cocktails 25mm



Mojito
SM-MOTOMOS

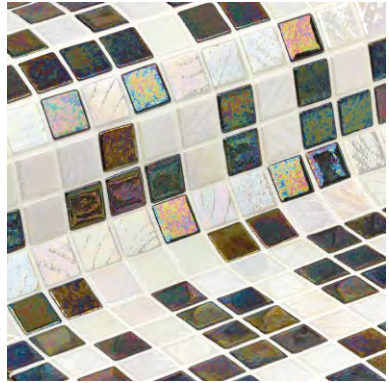

Manhattan
SM-MANHMOS

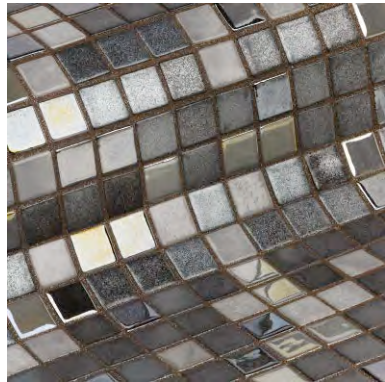

Gin Fizz
SM-GINFMOS

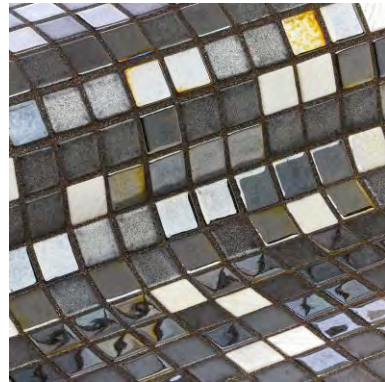

San Francisco
SM-SNFRMOS

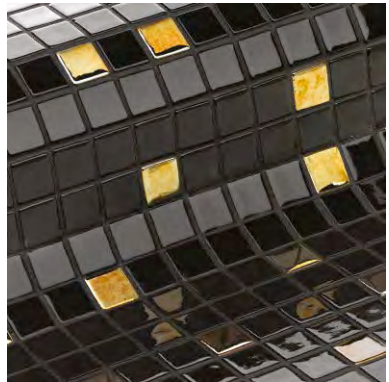

Eclipse
SM-ECLPMOS

All mosaics on this page are on a two week lead time





Cocktails 25mm

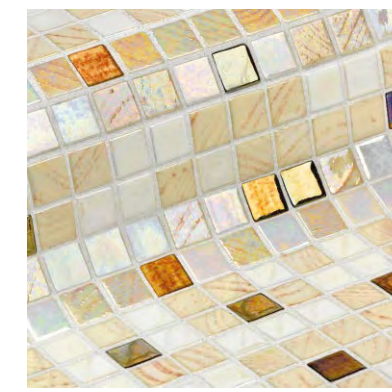

Daikiri
SM-DAKIMOS

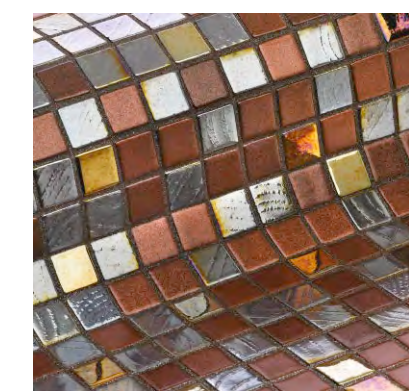

Bloody Mary
SM-BDMRMOS

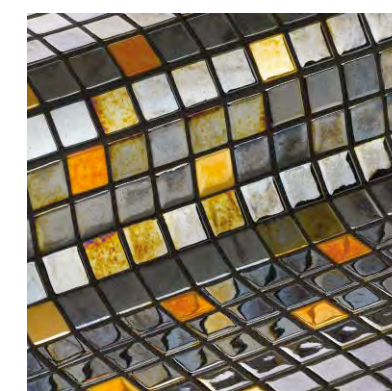

Margarita
SM-MARGMOS

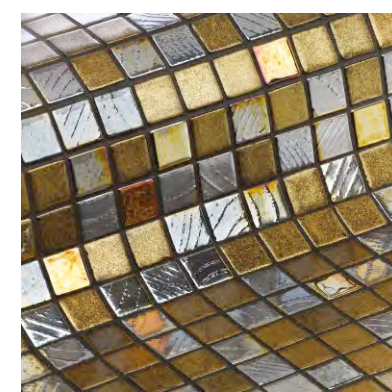

Kir Royal
SM-KIRRMOS

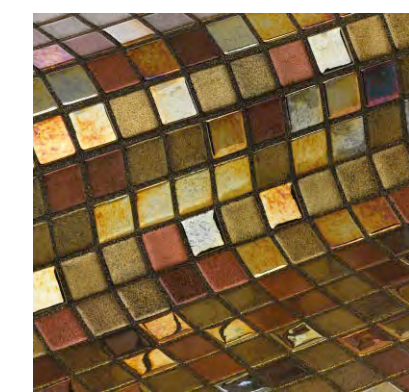

Cosmopolitan
SM-COSPMOS

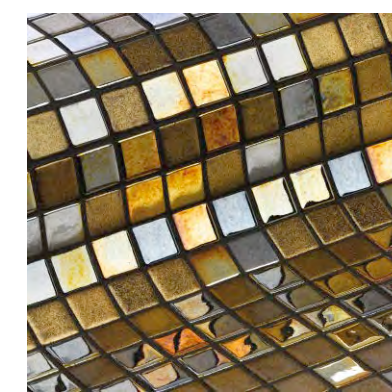

Alexander Ø
SM-ALEXMOS

All mosaics on this page are on a two week lead time

Zen 25mm

Achieve a sense of balance and harmony with Zen mosaics – a range inspired by natural stone, marble and wood.

See page 58-59 for Safe Step slip resistant options

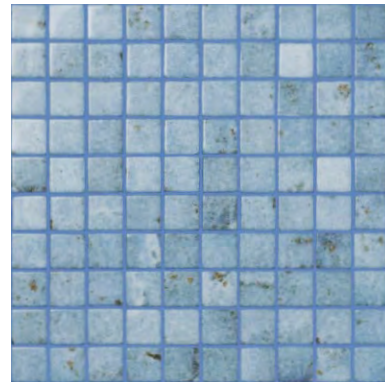

Makaba
SM-MAKAMOS

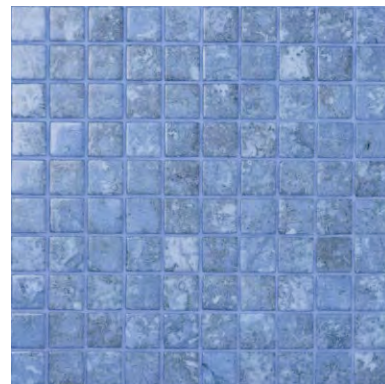

Bluestone
SM-BLSTMOS

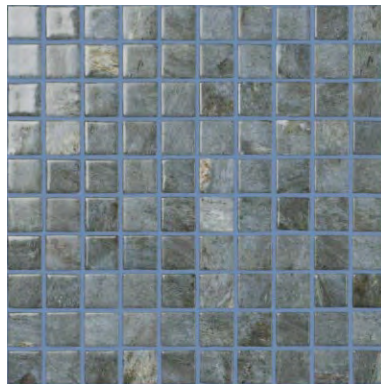

Dolerite
SM-DOLEMOS



All mosaics on this page are on a two week lead time



Carrara
SM-CARRMOS



Ash
SM-ZASHMOS



Sarsen
SM-SARSMOS



Pale Cherry
SM-PLCHMOS



Creamstone
SM-CREMMOS



Oak
SM-ZOAKMOS



Sandstone
SM-SNSTMOS



Travertino
SM-TRAVMOS

Zen 25mm



All mosaics on this page are on a two week lead time

Zen 25mm

See page 58-59 for Safe Step slip resistant options



Fior Di Bosco
SM-FIORMOS



Δ **Palisandro**

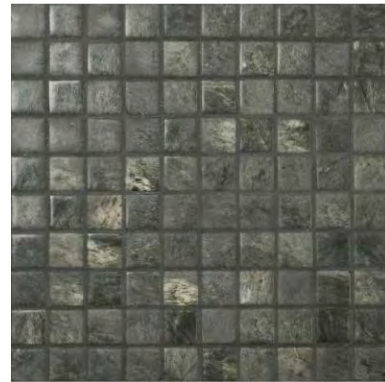

Phyllite
SM-PHYLMOS



Tigrato
SM-TIGRMOS



Palisandro
SM-PALIMOS

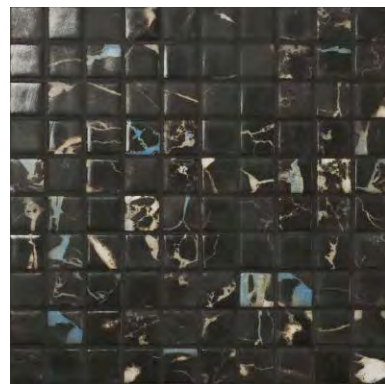

Black Marble
SM-BLKMMOS



Rustic
SM-RUSTMOS

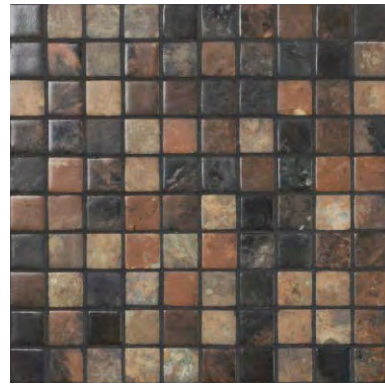

Riverstone
SM-RVSTMOS



All mosaics on this page are on a two week lead time

Iris 25mm

Choose Iris for dazzling iridescence and stunning colours. Now available in six new mixed blends.

See page 57 for Safe Step slip resistant options

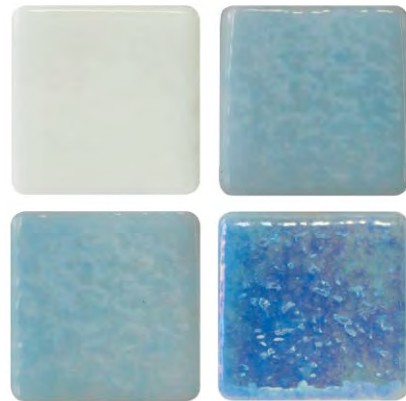

new Sky
SM-SKYMIXMOS

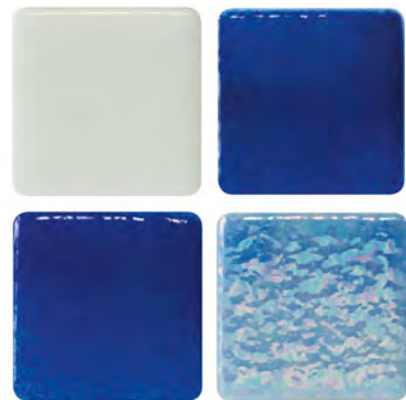

new Oasis
CODE

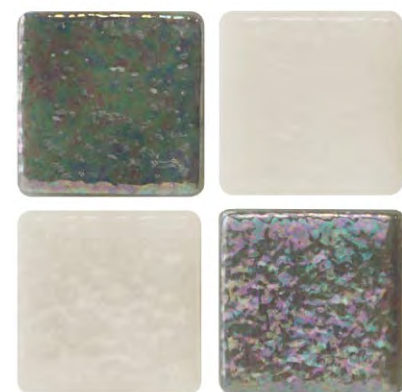

new Stone
SM-STNEMOS

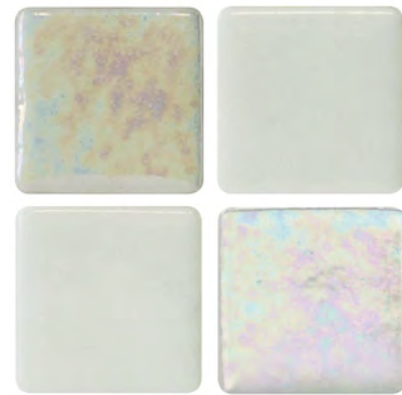

new Diamond
SM-DIAMMOS



new Moon
CODE



new Sahara
SM-SAHMIXMOS

Iris 25mm

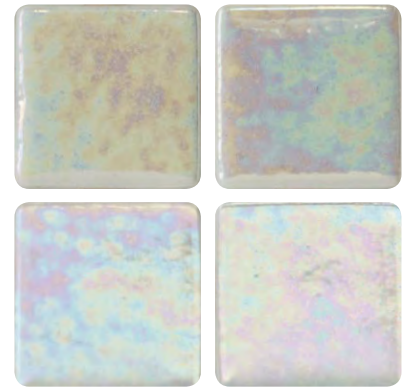

Perla ◊
SM-PERLMOS

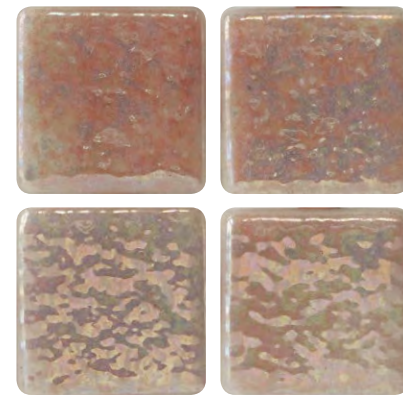

Nacar
SM-NCARMOS

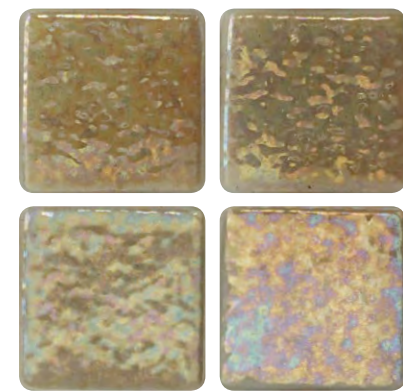

Arena
SM-ARENMOS

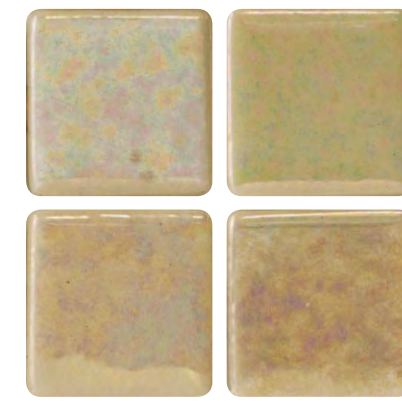

MARFIL
SM-MRFLMOS

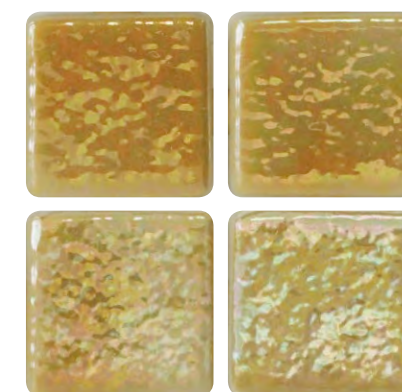

Ambar
SM-AMBAMOS

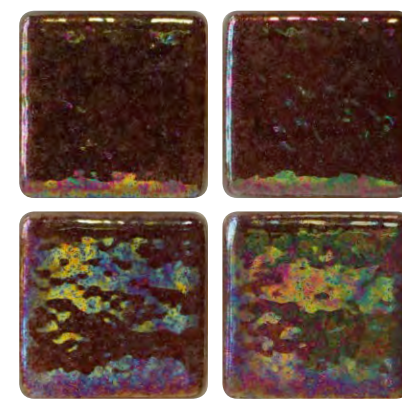

Cobre
SM-COBRMOS

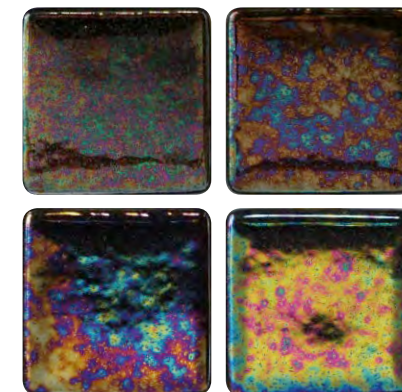

Ebano ◊
SM-EBANMOS

All mosaics on this page are on a two week lead time

◊ These products are available from stock. All other mosaics on this page are on a two week order basis.

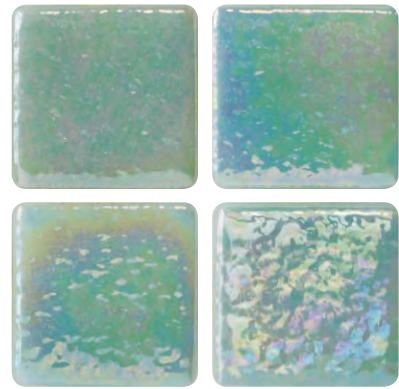

CORAL
SM-CORLMOS

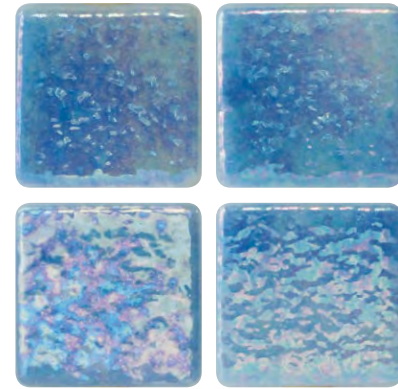

Azur
SM-AZURMOS

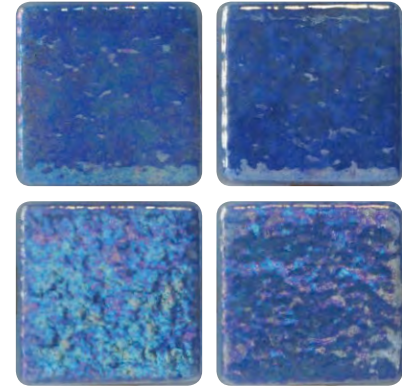

Ocean
SM-OCENMOS

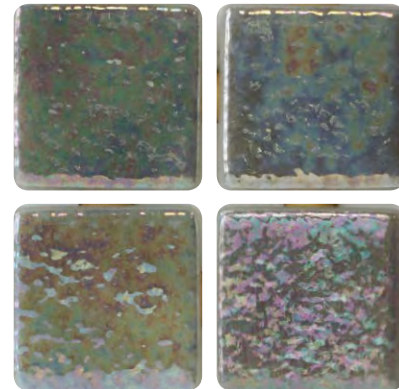

Cuarzo
SM-CRZOMOS

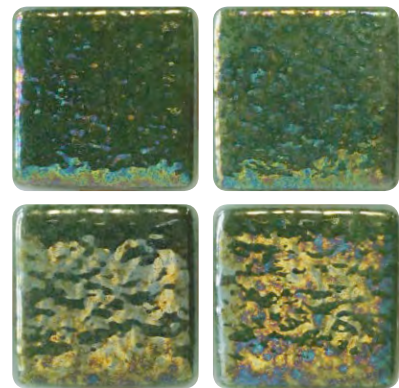

GREEN PEARL
SM-GNPLMOS

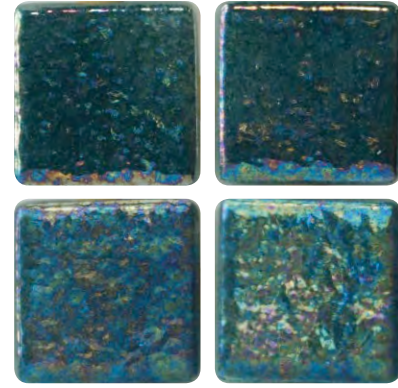

Jade
SM-JADEMOS

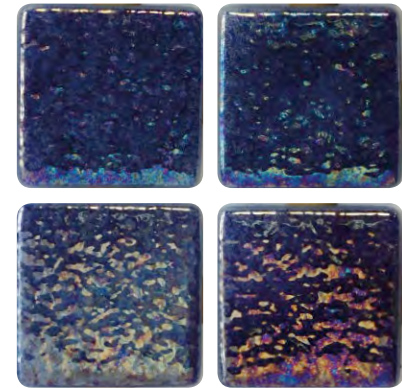

Zafiro
SM-ZAFRMOS

Iris 25mm

See page 57 for Safe Step slip resistant options



All mosaics on this page are on a two week order basis.



Capricorn
SM-CAPRMOS



Sagittarius
SM-SAGIMOS



Taurus
SM-TAUMOS

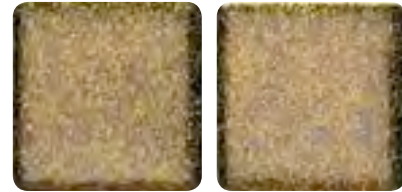

Aquarius
SM-AQUAMOS

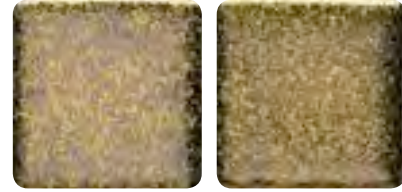

Scorpio
SM-SCORMOS

Space ^{25mm}

Nebulous colours with a flecked metallic appearance

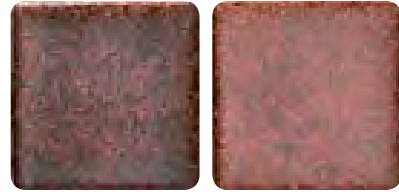
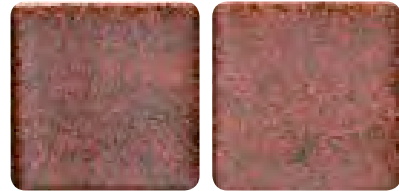

Leo
SM-LEOMOS



All mosaics on this page are on a two week lead time

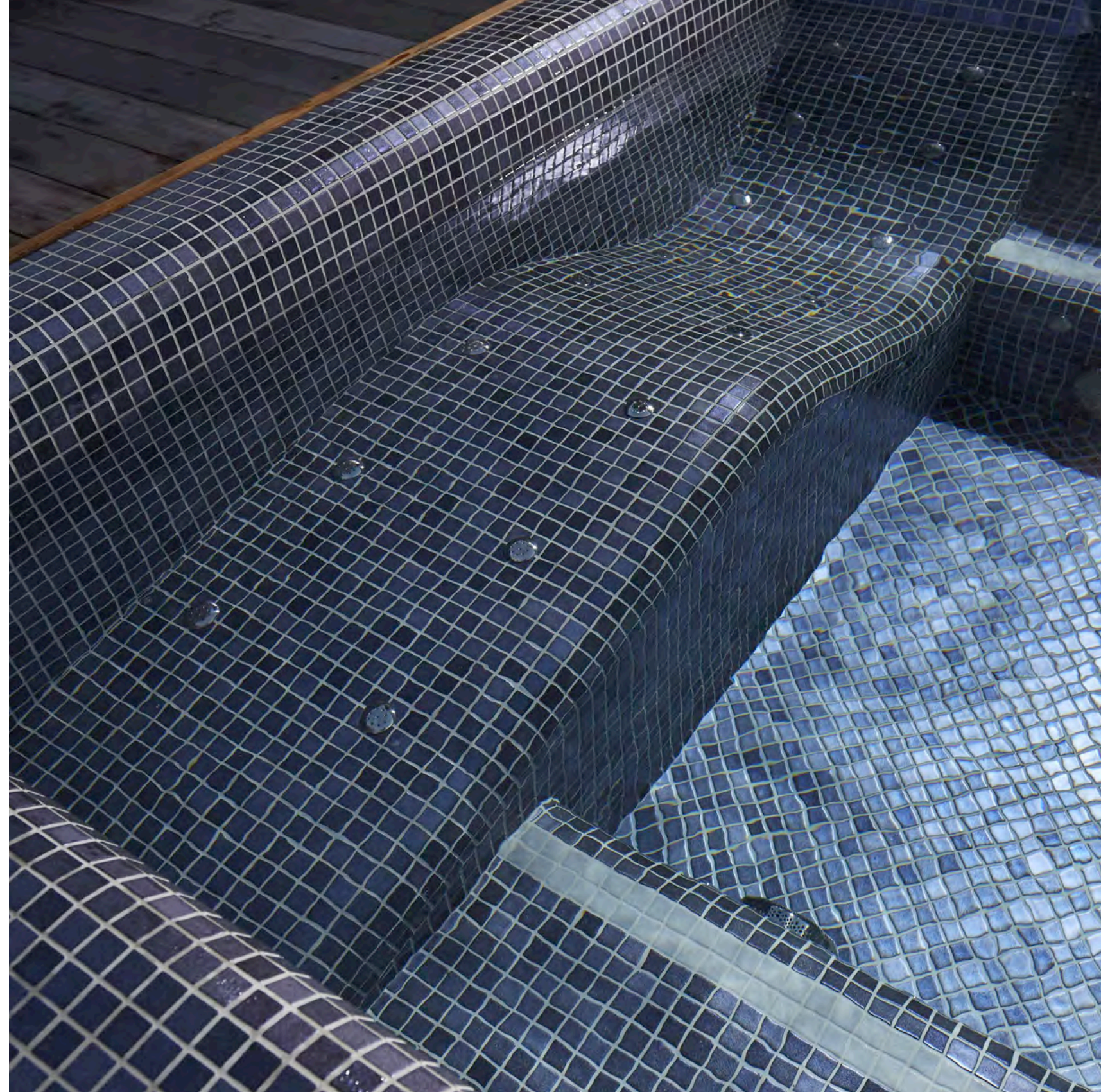

Fosfo 25mm



Glow in the dark mosaics, charged with natural or artificial light. Available in random patterns or full-on light show effect.

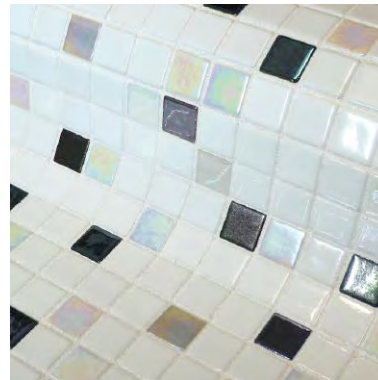

Draco
SM-DRAMOS



Lepus
SM-LEPMOS

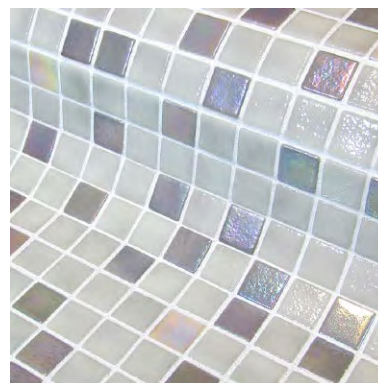

Serpens
SM-SERMOS

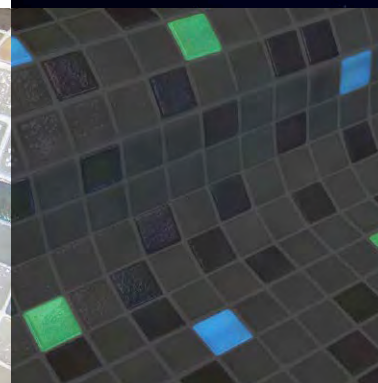

Luminescent pigments in these tiles are charged by exposure to light, therefore the intensity and longevity of the glow-in-the-dark effect will vary depending on the prevailing lighting conditions.

All Fosfo mosaics are on a two week order basis.



All Fosfo mosaics are on a two week order basis.

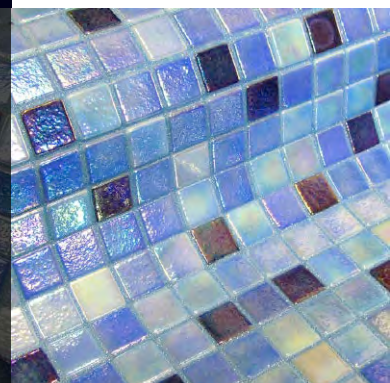

Delphinus
SM-DELMOS



Fosfo 25mm
glow in the dark



Fosfo 25mm

Glow in the dark mosaics, charged with natural or artificial light.

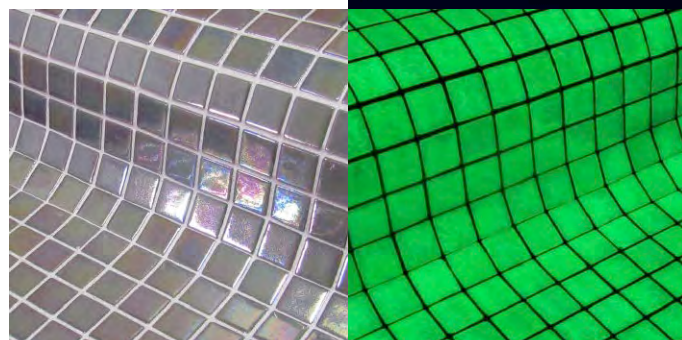

Fosfo Grey-Iris

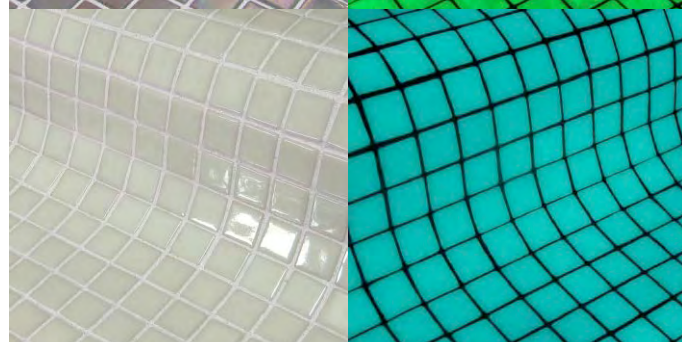

Fosfo

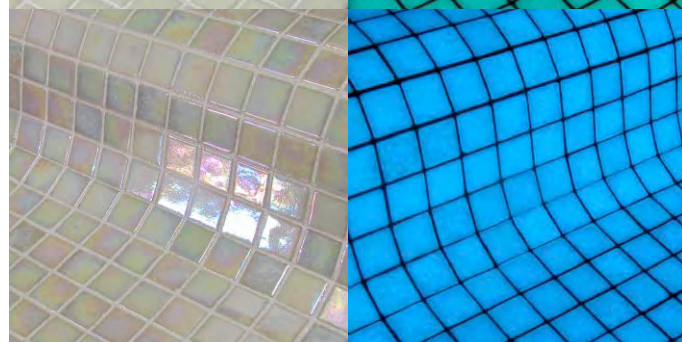

Fosfo Beige-Iris

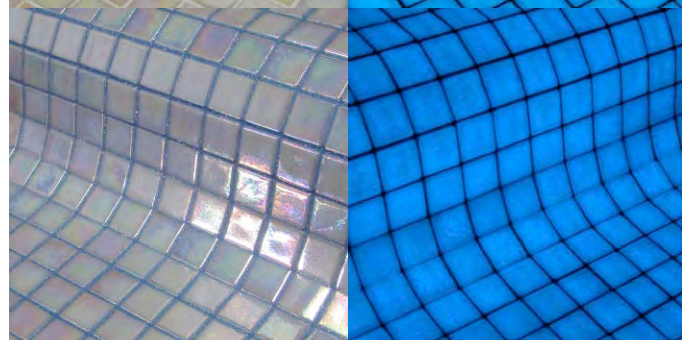

Fosfo Blue-Iris

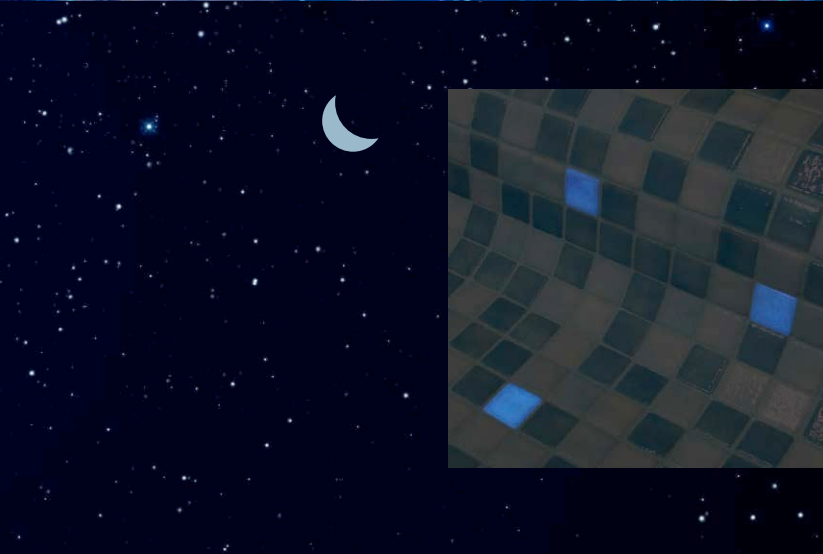

Aquila
SM-AQLMOS



Argo
SM-ARGMOS

Luminescent pigments in these tiles are charged by exposure to light, therefore the intensity and longevity of the glow-in-the-dark effect will vary depending on the prevailing lighting conditions.

All Fosfo mosaics are on a two week order basis.



All Fosfo mosaics are on a two week order basis.

Fosfo 25mm
glow in the dark

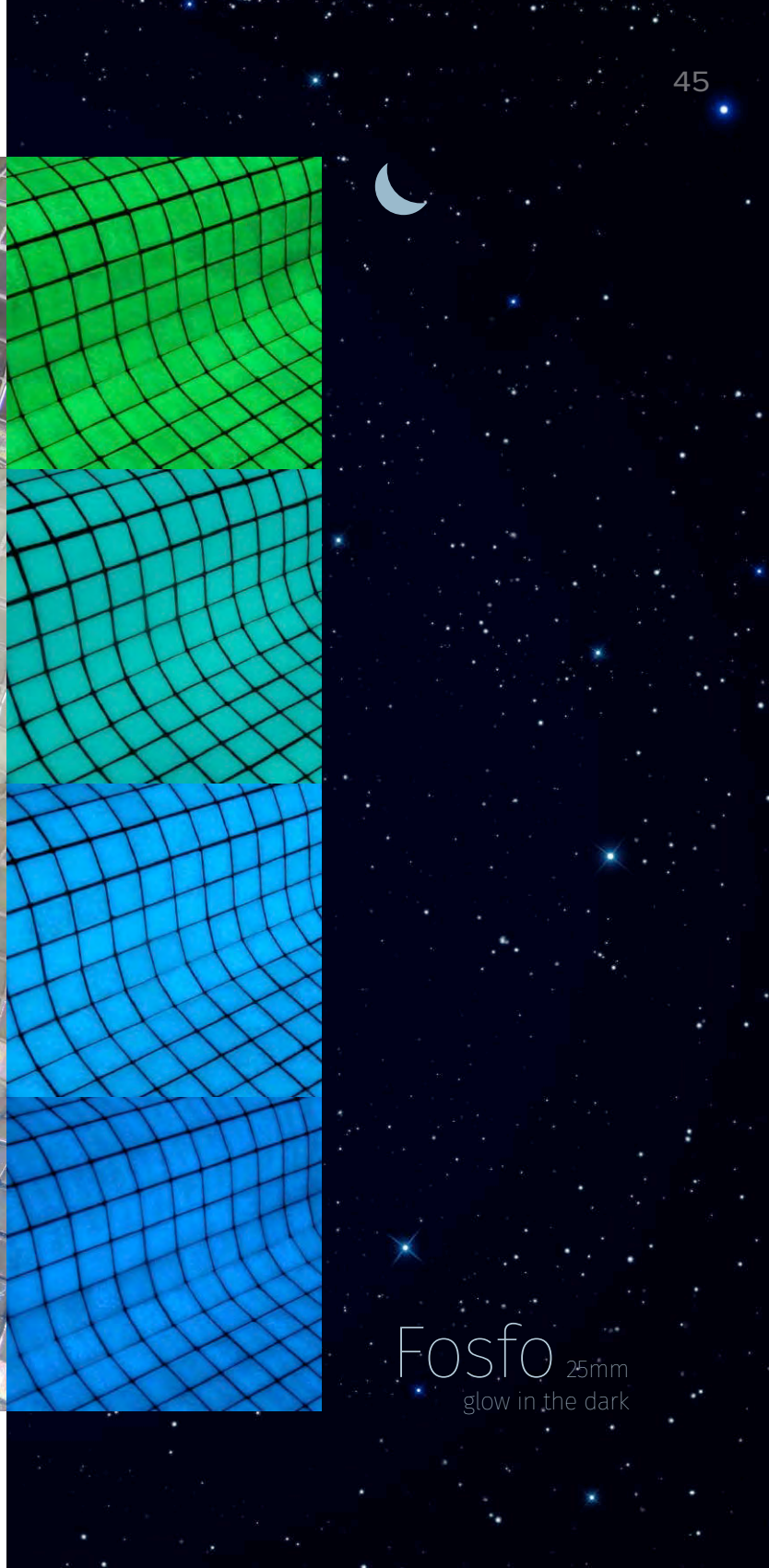
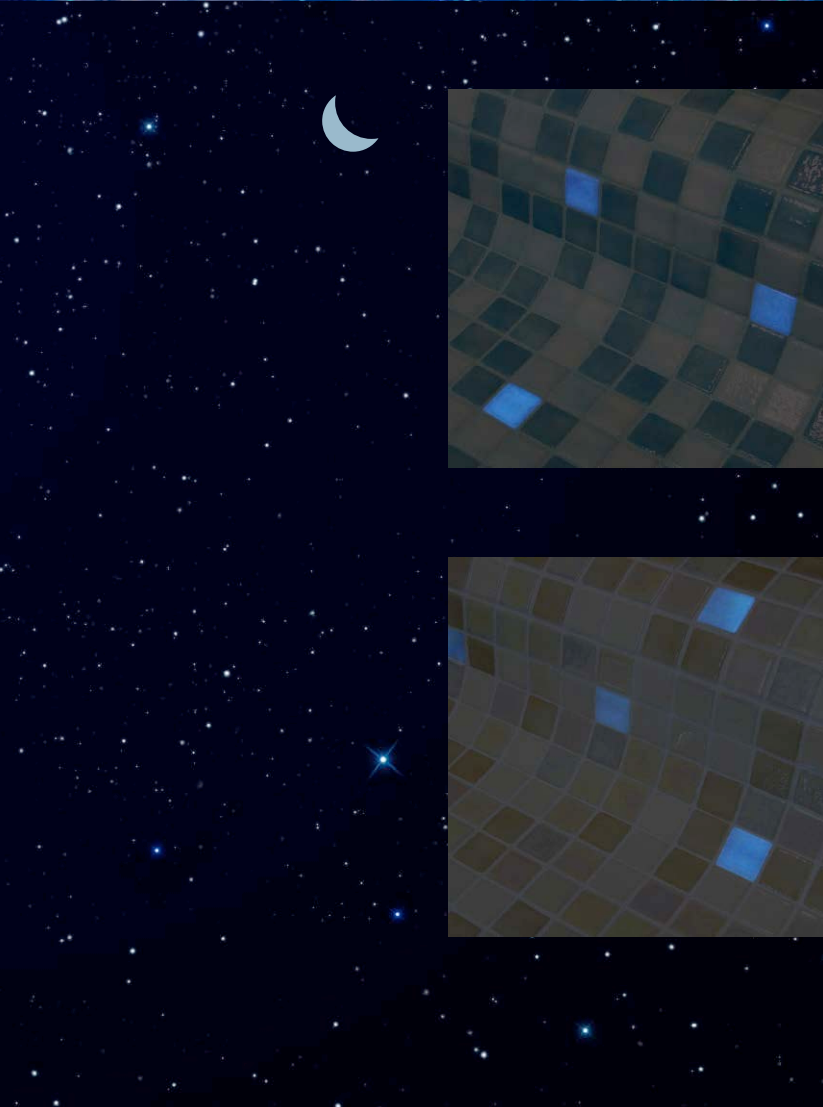



Metal_{25mm}

This stunning range in glass (not really metal at all) offers a sophisticated elemental look that is both contemporary and timeless



Inox
SM-INOXMOS

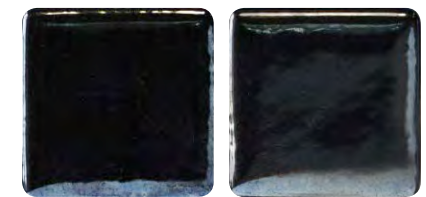
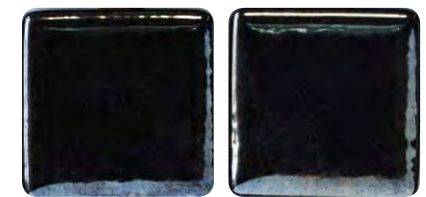

Lava
SM-LAVAMOS

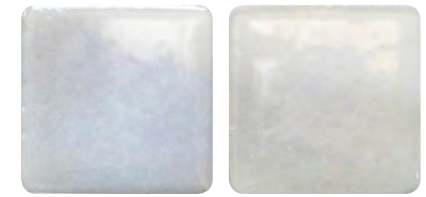

Nickel
SM-NICKMOS

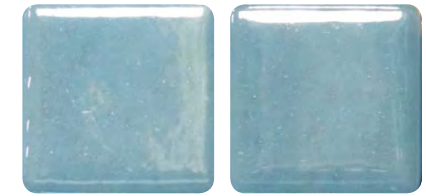

Vanadium
SM-VANAMOS

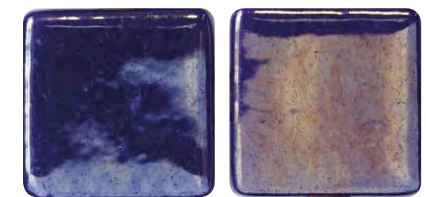

Azurita
SM-AZTAMOS

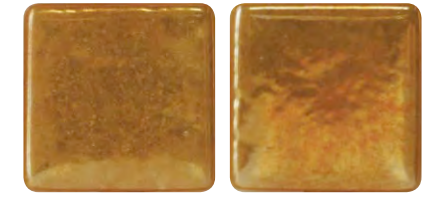
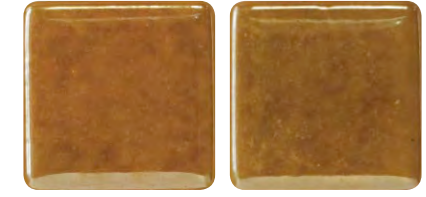

Aurum
SM-AURUMOS



OPALO
SM-OPALMOS



Rubi
SM-RUBIMOS

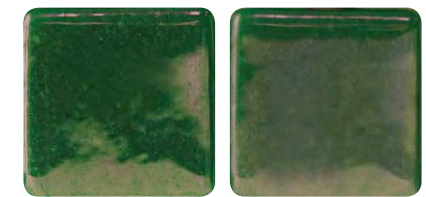

Esmerelda
SM-ESMMOS



Oxido
SM-OXIDMOS

All Metal mosaics are on a two week order basis.

Niebla

25mm, 36mm, 50mm

From the Spanish for 'fog' or 'mist'. Beautiful clouds of colour infused in to glass.

See page 60-64 for Safe Step slip resistant options

25mm mosaics shown actual size (36 & 50mm available in selected colours)

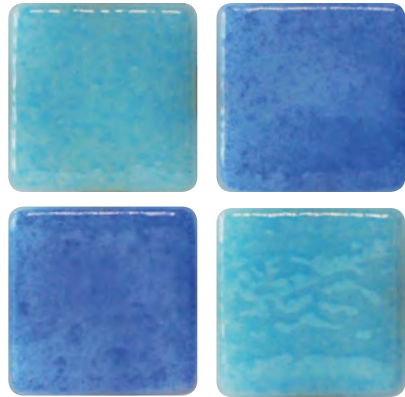

SM-25004MOS

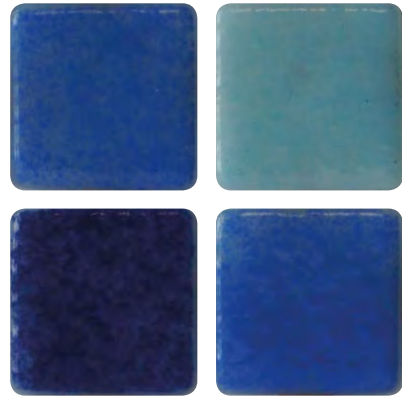

SM-25002MOS

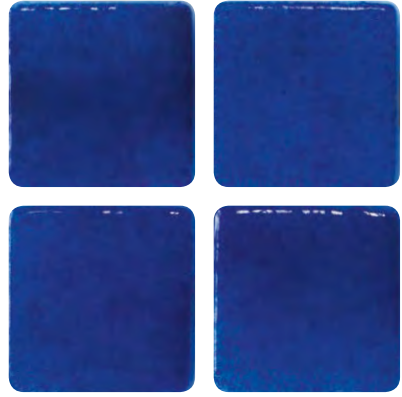

SM-2512MOS
3612-C
5012-C

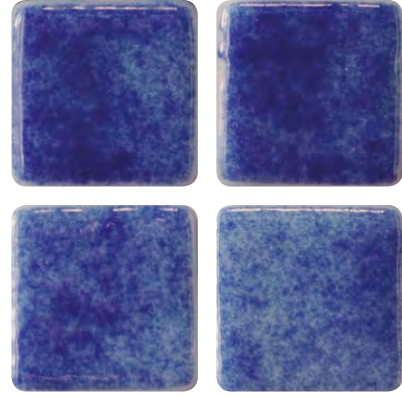

SM-2562MOS ◊
3662-B
5062-B

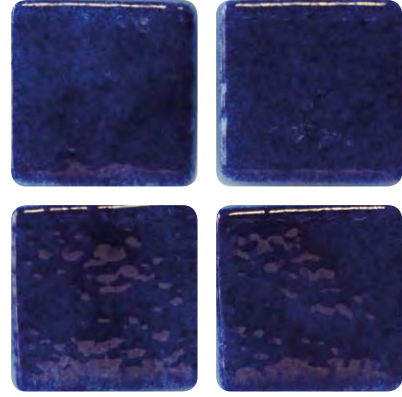

SM-2503MOS
3603-D
5003-D



SM-2529MOS
3629-B
5029-B

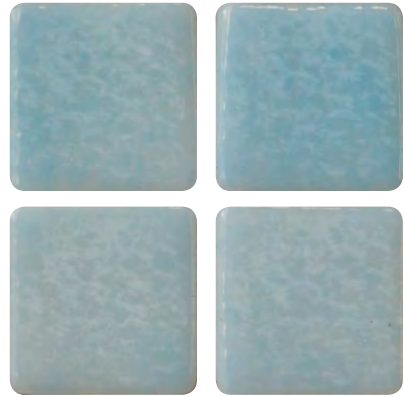

SM-2521MOS
3621-B
5021-B

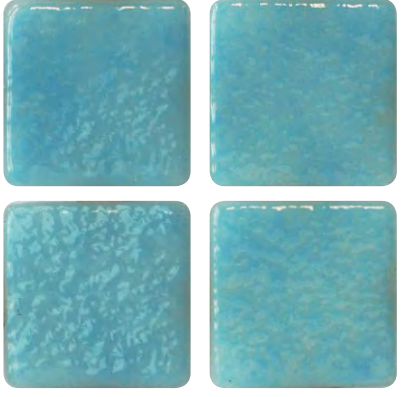

SM-2508MOS ◊
3608-A
5008-A

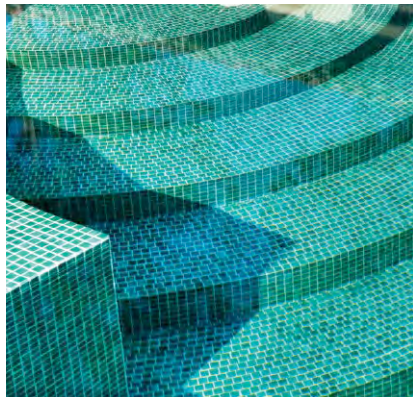

△ SM-2586MOS

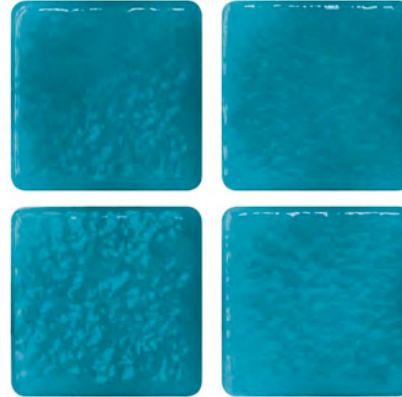

SM-2502
3602-A
5002-A



SM-2505MOS ◊
3605-A
5005-A



SM-2522MOS
3622-B
5022-B

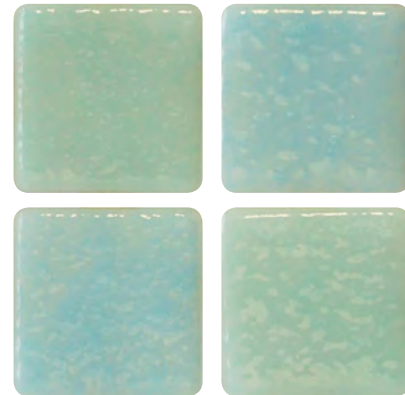

SM-2518MOS ◊
SM-3618MOS



SM-2510MOS ◊
3610-A
5010-A

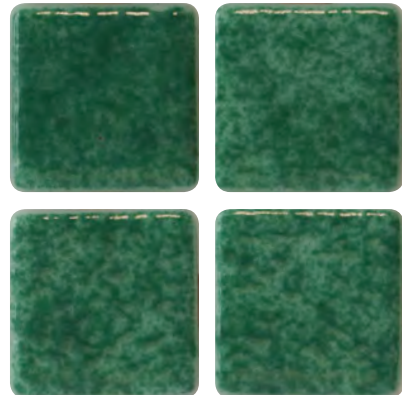

SM-2586MOS
3686-B
5086-B



SM-2507MOS
3607-A
5007-A

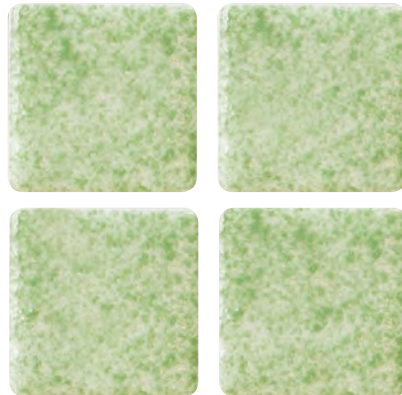

SM-2585MOS
3685-B
5085-B

All mosaics on this page are on a two week lead time

◊ These products are available from stock. All other mosaics on this page are on a two week order basis.

Niebla

25mm, 36mm, 50mm

See page 60-64 for Safe Step slip resistant options

25mm mosaics shown actual size
(36 & 50mm available in selected colours)



2523-B
3623-B
5023-B

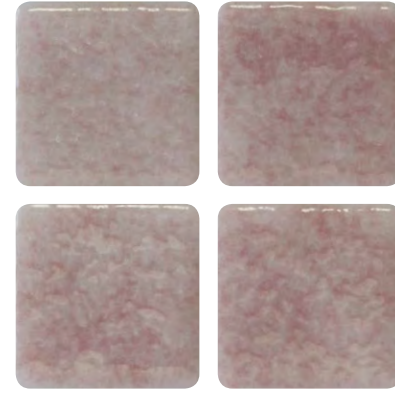

2524-B
3624-B
5024-B

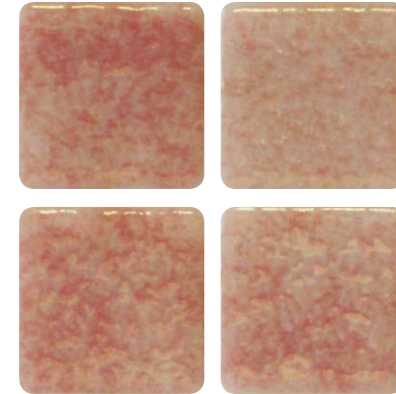

SM-2564MOS
3664-B
5064-B

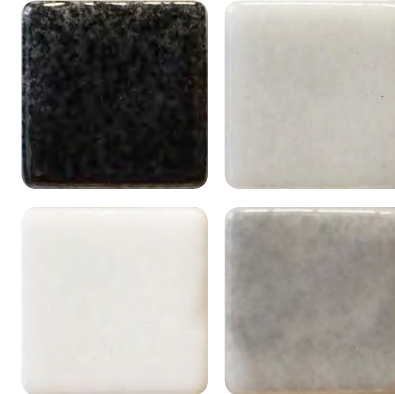

SM-25008MOS (25mm only)

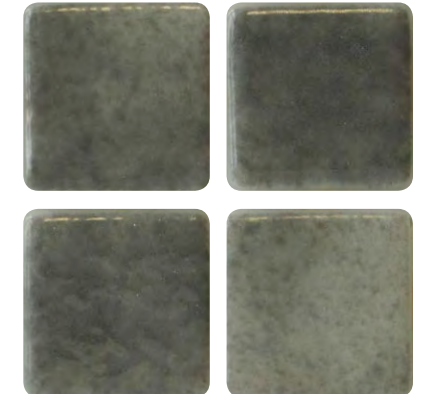

SM-2560MOS
3660-A
5060-A



SM-2596MOS
3696-B
5096-B



SM-2597MOS
3697-B
5097-B



SM-2576MOS
3696-B
5096-B

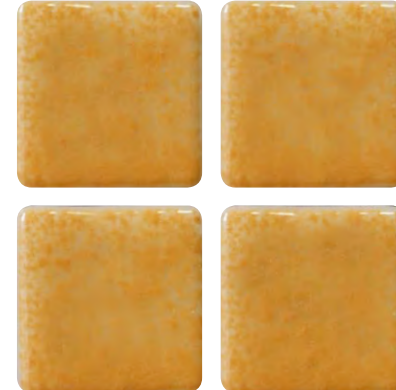

2511-A
3611-A
5011-A



2504-A
3602-A
5002-A

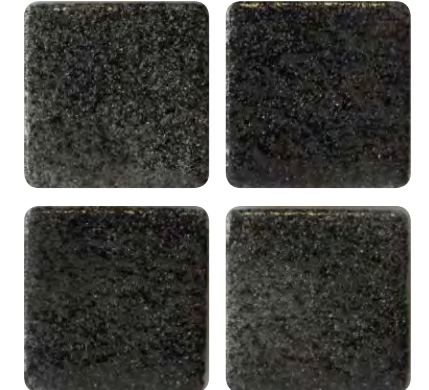

SM-2516MOS
3616-B
5016-B



2525-B
3625-B
5025-B



SM-2526MOS
3626-B
5026-B



2513-A
3613-A
5013-A

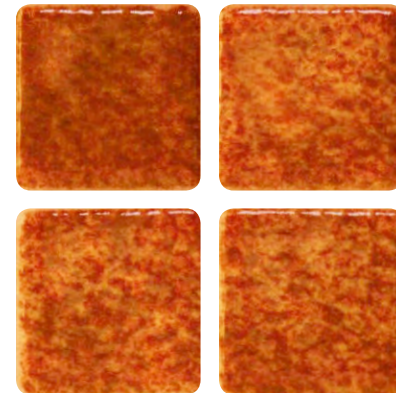

2509-C
3609-C
5009-C

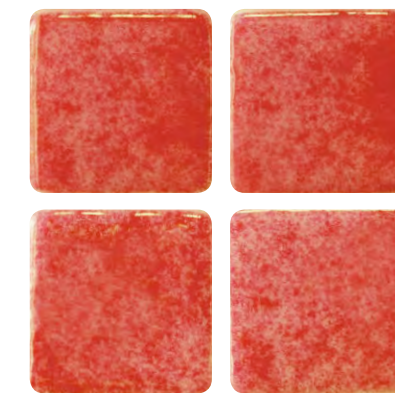

SM-2506MOS
3606-C
5006-C

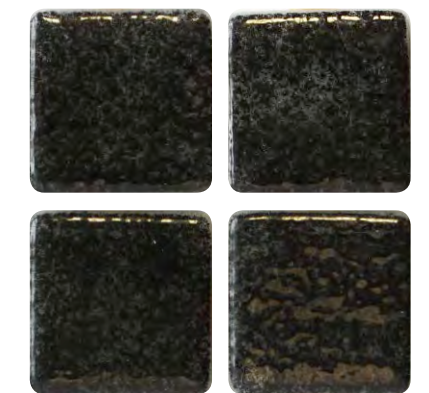

SM-2501MOS
3601-B
5001-B

All mosaics on this page are on a two week lead time

◊ These products are available from stock.
All other mosaics on this page are on a two week order basis.

Lisa 25mm, 36mm

Solid colours in a range of tones to use on their own, or to contrast and define

25mm mosaics shown actual size
(36mm available in selected colours)



2549-A
3649-A



2548-C
3648-C

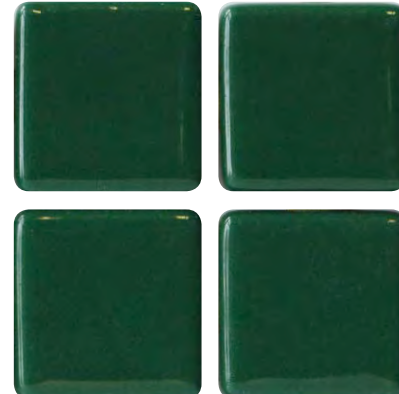

SM-2555MOS
3655-C



SM-2551MOS
3651-A



2546-A
3646-A

All mosaics on this page are on a two week lead time



SM-2534MOS
3634-A

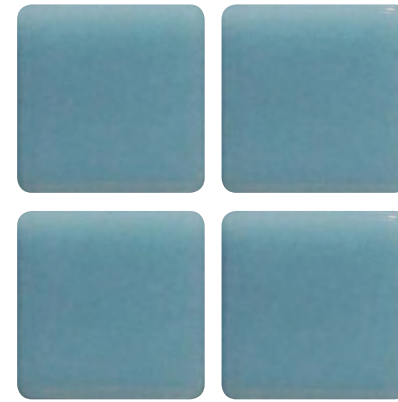

2547-A
3647-A

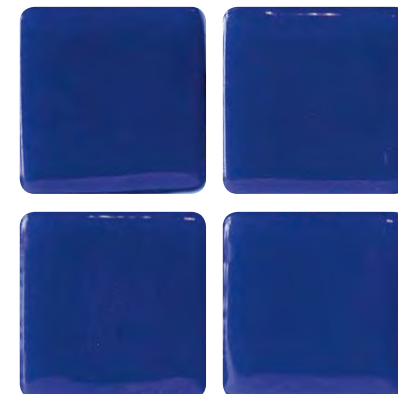

2557-D
3657-D

All mosaics on this page are on a two week lead time

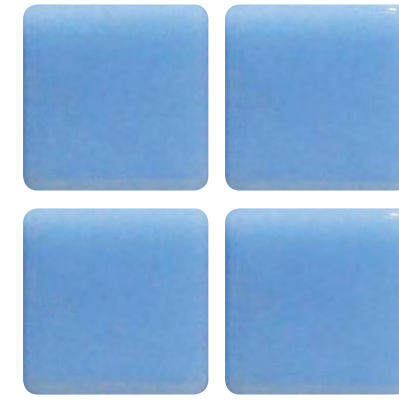

2541-A
3641-A

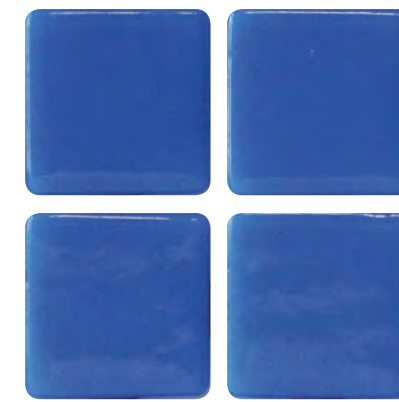

SM-2542MOS
3642-B



2556-C
3656-C

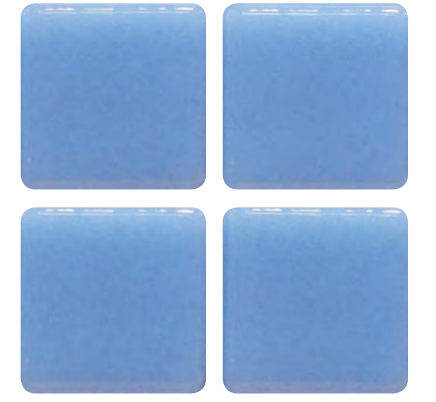

SM-2535MOS
3635-A

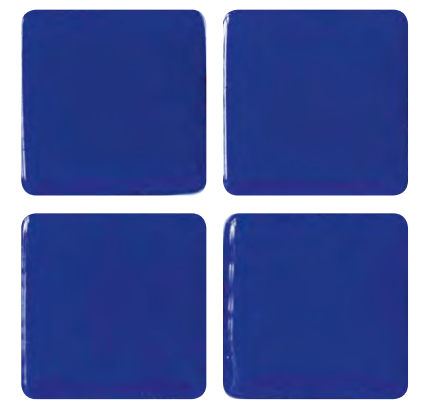

2536-C
3636-C

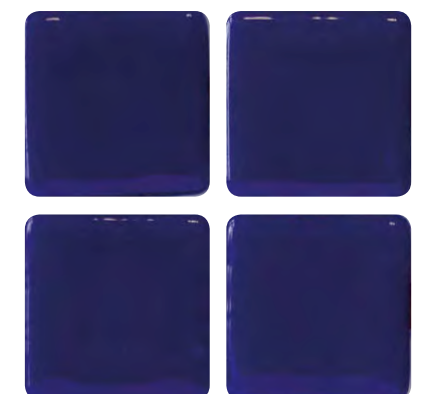

SM-2543MOS
3643-D



2554-C
3654-C



2539-B
3639-B



2533-A
3633-A

Lisa 25mm, 36mm

25mm mosaics shown actual size
(36mm available in selected colours)



SM-2545MOS ◊
3645-A
5045-A



2544-A
3644-A



SM-2530MOS ◊
3630-D



SM-2559MOS
3659-B

All mosaics on this page are on a two week lead time



2558-B
3658-B



2531-B
3631-B



SM-2538MOS
3638-D

All mosaics on this page are on a two week lead time



2553-B
3653-B



2532-B
3632-B



2552-A
3652-A



SM-2537MOS
3637-E

Lisa 25mm, 36mm

25mm mosaics shown actual size
(36mm available in selected colours)



Safe Step Mosaics

Step edges, wet room or steam room floors can be both stylish and safe with these slip resistant mosaics. A wide range of colours means they can be used to co-ordinate or contrast with other shades. Featuring a refined new finish called 'Safe Step', these mosaics have a softer feeling, foot friendly surface while maintaining good levels of slip resistance.

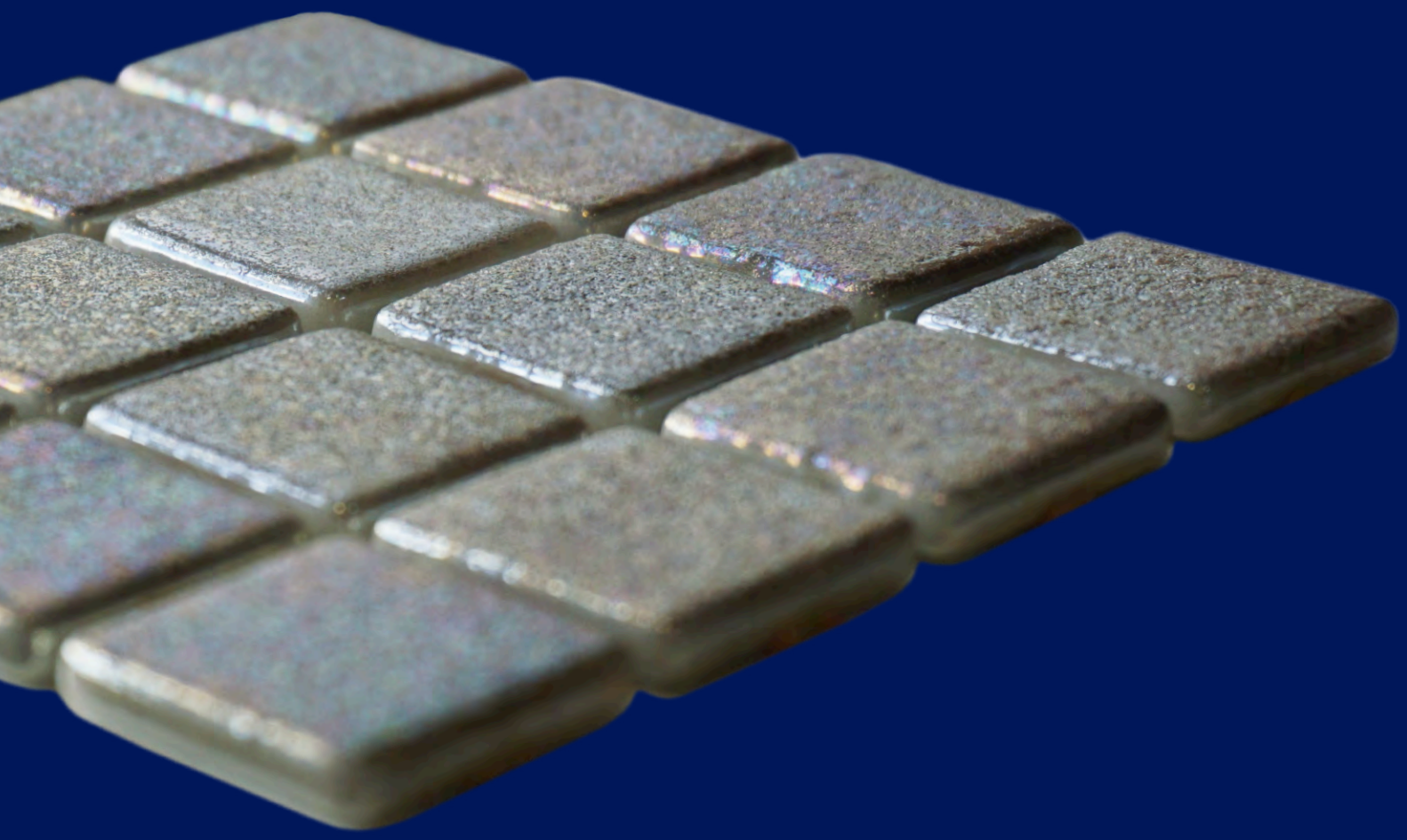

Iris safe Step ^{new} 25mm

Technical characteristics
Tested to: BS7976-2
Barefoot Wet (TRRL55 Wet) >44

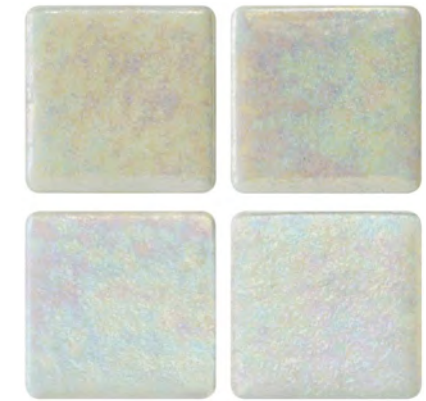

Perla Safe Step
SM-PERLMOS-SAS

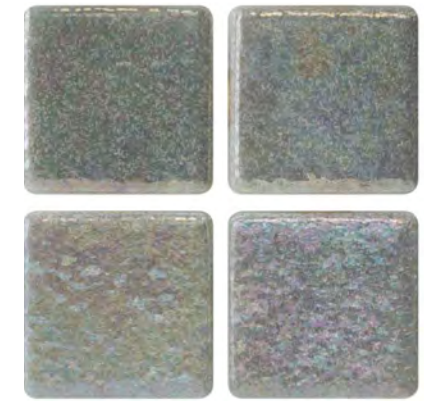

Cuarzo Safe Step
SM-CRZOMOS-SAS

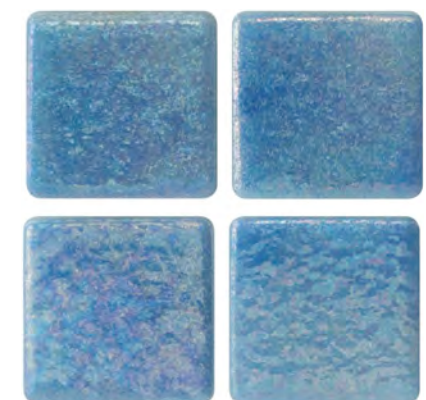

Azur Safe Step
SM-AZURMOS-SAS

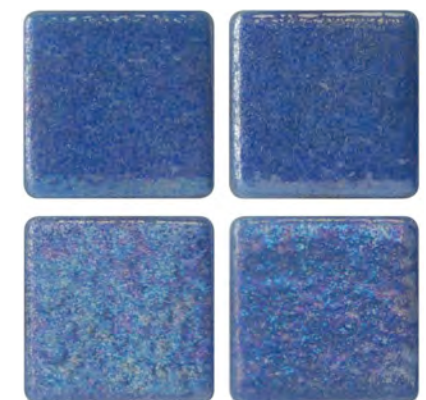

Ocean Safe Step ◊
SM-OCENMOS-SAS

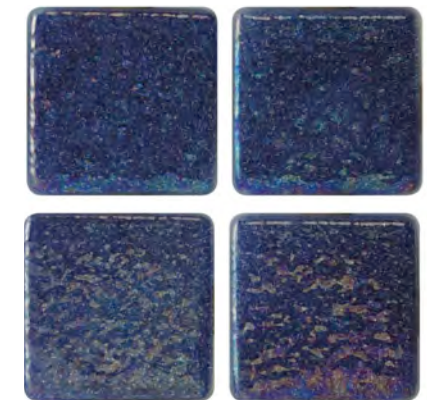

Zafiro Safe Step
SM-ZAFRMOS-SAS

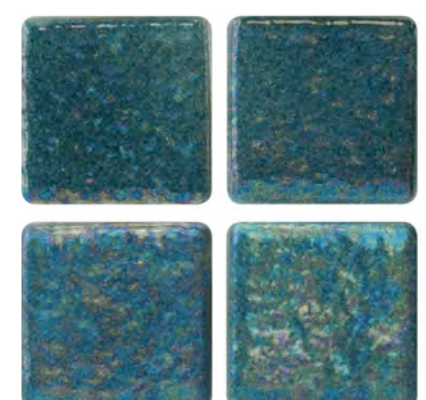

Jade Safe Step
SM-JADEMOS-SAS

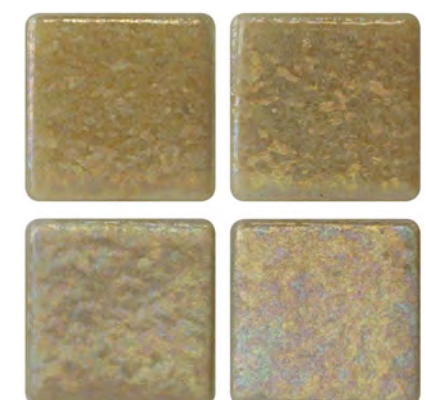

Arena Safe Step ◊
SM-ARENMOS-SAS

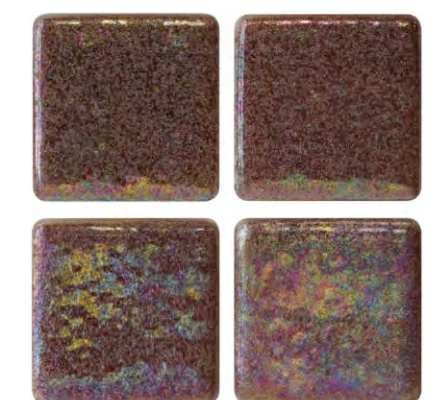

Cobre Safe Step
SM-COBRMOS-SAS

◊ These products are available from stock.
All other mosaics on this page are on a two week order basis.

Zen safe Step 25mm ^{new}



Fior Di Bosco
SM-FIORMOS



Pale Cherry
SM-PLCHMOS



Sarsen
SM-SARSMOS



Tigrato
SM-TIGRMOS



Creamstone
SM-CREMMOS



Sandstone
SM-SNSTMOS



Carrara
SM-CARRMOS



Ash
SM-ZASHMOS

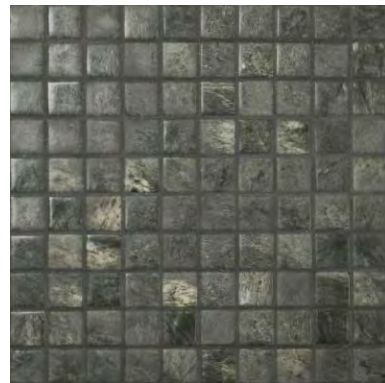

Phyllite
SM-PHYLMOS



Oak
SM-ZOAKMOS



Travertino
SM-TRAVMOS

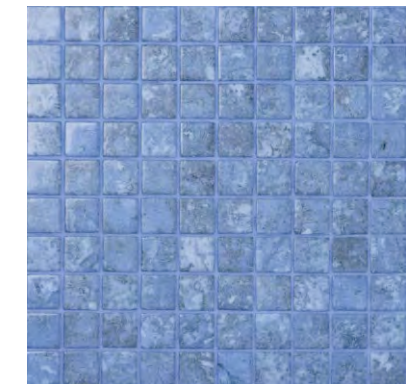

Bluestone
SM-BLSTMOS

All mosaics on this page are on a two week lead time

All mosaics on this page are on a two week lead time

Zen safe Step 25mm ^{new}

Technical characteristics
Tested to: BS7976-2
Barefoot Wet (TRRL55 Wet) >44



Niebla safe Step ^{new}

25mm, 50mm

Technical characteristics
Tested to: BS7976-2
Barefoot Wet (TRRL55 Wet) >44

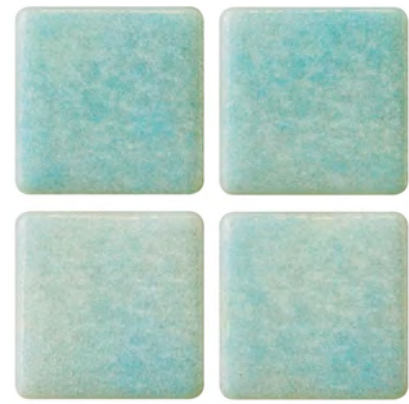

2529-SAS

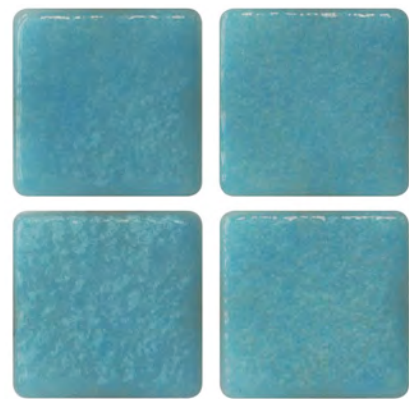

SM-2508MOS-SAS

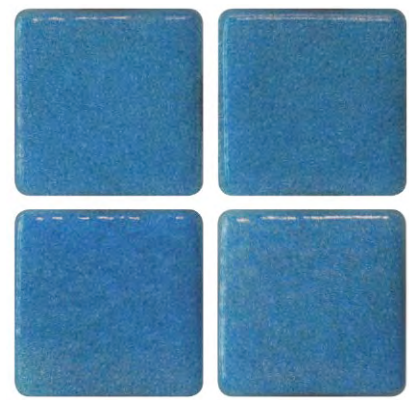

SM-2505MOS-SAS ◊



SM-2545MOS-SAS ◊
SM-5045MOS-SAS

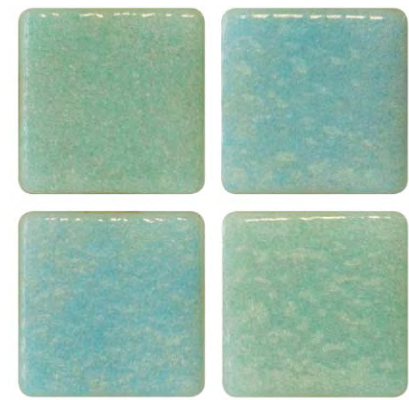

SM-2518MOS-SAS



SM-2521MOS-SAS

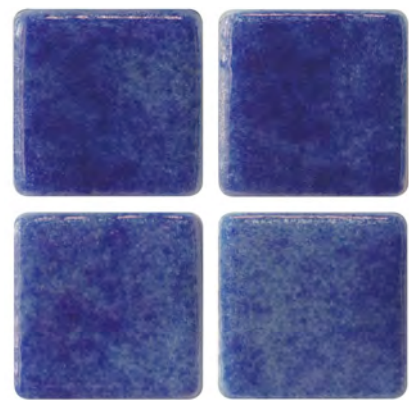

2562-SAS



2522-SAS



2507-SAS



2502-SAS
3602-SAS



SM-2503MOS-SAS ◊

◊ These products are available from stock.
All other mosaics on this spread are on a two week order basis.





Niebla Safe Step 25mm, 50mm new

Technical characteristics
 Tested to: BS7976-2
 Barefoot Wet (TRRL55 Wet) >44



2514-SAS		2523-SAS		SM-2596MOS-SAS	SM-5096MOS-SAS
SM-2576MOS-SAS ◊		2511-SAS		2509-SAS	
SM-2560MOS-SAS ◊	SM-5060MOS-SAS	SM-2516MOS-SAS ◊	SM-5016MOS-SAS	SM-2504MOS-SAS	

◊ These products are available from stock.
 All other mosaics on this page are on a two week order basis.

Niebla Safe Step Edges

With the same slip resistant texture as the mosaics, these innovative corner pieces provide seamless and safe edging for the transition from pool side to pool and for step areas.

At 52mm in length, the pieces are also small enough to be used effectively to create curves. Sharp edges are completely eliminated with these corner pieces.

- New low-abrasion Safe Step finish
- Slip resistant for safety
- For pool edges both straight and curved, step edges
- Attractive finishing piece
- Easy to install at the same time as the tiling

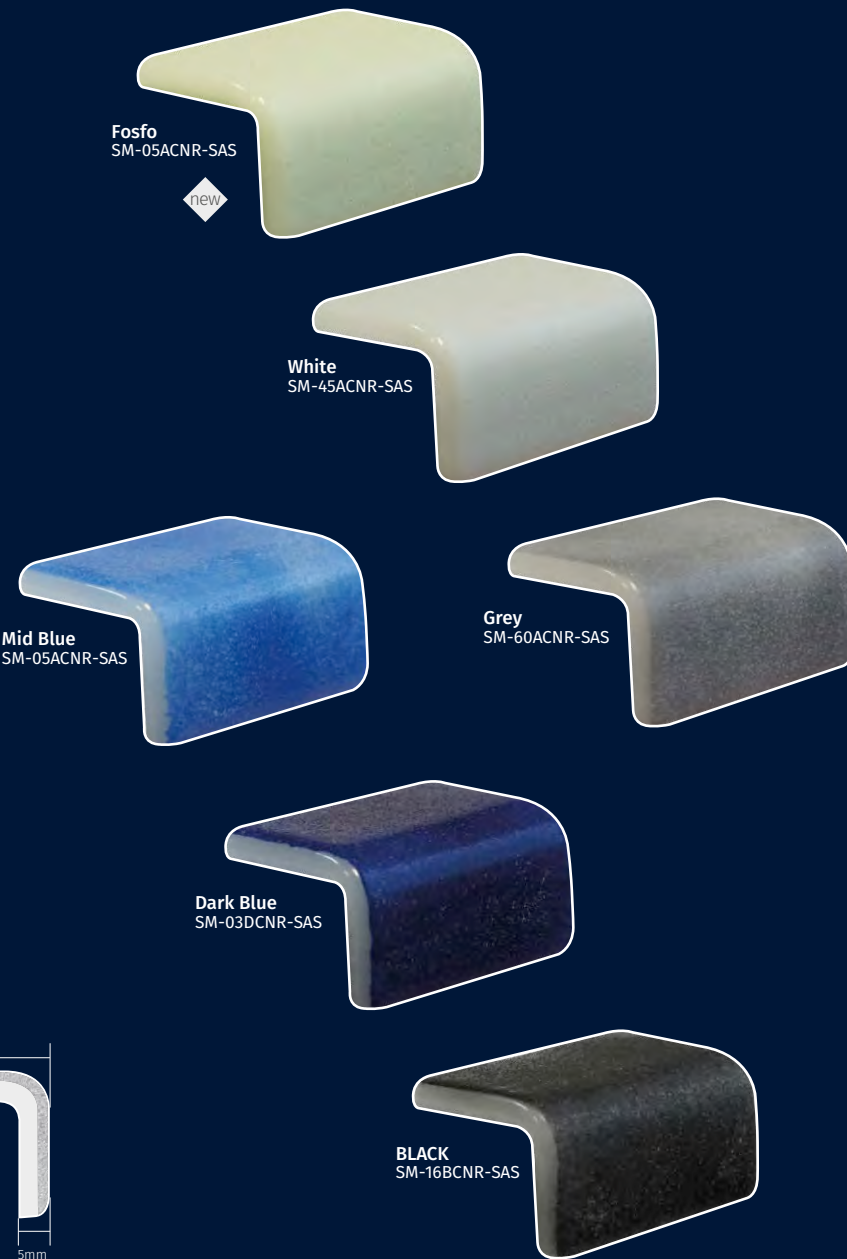

JointPoint®

Mosaics shown in the previous section displaying the JointPoint® symbol () use a technologically advanced system of silicone connections to hold individual mosaics together in panels. The silicone points are on the reverse of the mosaics and are designed to ensure that the sheets are laid uniformly, with up to 92% of the surface available for the application of adhesive, which results in better adhesion and superior grip. JointPoint® is very easy to work with and install – the sheets are flexible, controllable and easy to cut.

All JointPoint® mosaics shown on pages 27-63	
Individual tile size	Sheet size
25 x 25 x 5mm	312 x 495mm
36 x 36 x 5mm	334 x 334mm
50 x 50 x 5mm	365 x 365mm
98% of the glass used as a raw material in the production process is recycled	

WATER IMMERSION TENSILE ADHESION STRENGTH

Each family type of mesh/glue backing system for mosaic tiles, recommended for water submerged conditions (not salt water), are tested in accordance with BSEN 1348:2007 Determination of Tensile Adhesive Strength for Cementitious Adhesives.

The tests are conducted by a UKAS accredited testing laboratory, number 0013. The mean value of water immersion tensile adhesion strength is determined for each family type of mesh/glue backing system after allowing for any discarded samples.

EN 12004:2007 + A1:2012 states that the tensile values for a C2 adhesive must be greater than or equal to 1.0 N/mm². Each family type of mesh/glue backing system meets this requirement. For example, the JointPoint® family type of mesh/glue backing system yielded a result of 1.3 N/mm².

It must be noted that each family mesh/glue backing system for mosaics is tested using Ardex x77 C2 adhesive. All test materials, including the adhesive being tested, were conditioned as required by the test method BSEN 1348:2007. The Ardex x77 adhesive was prepared in accordance with clause 7.0 of the EN 1348 standard.

Ardex x77 C2 adhesive is the recommended product for use with all JointPoint® Designworks/Original Style swimming pool mosaic tiles installed in submerged conditions. For salt water swimming pools we recommend the use of an epoxy adhesive only.

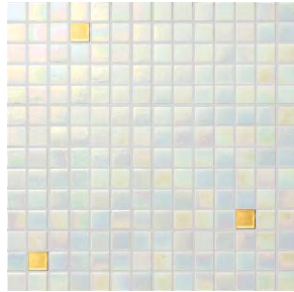

Iris Pura Gold
20mm SM-TR796G1MOS (shown)
10mm SM-TR796G1MOS10



St Tropez Gold
20mm SM-TR242G1MOS (shown)
10mm SM-TR242G1MOS10



Mediterrano Gold
20mm SM-TR244G1MOS (shown)
10mm SM-TR244G1MOS10

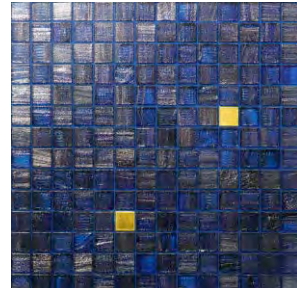

Sapphire Gold
20mm SM-TR239G1MOS (shown)
10mm SM-TR239G1MOS10

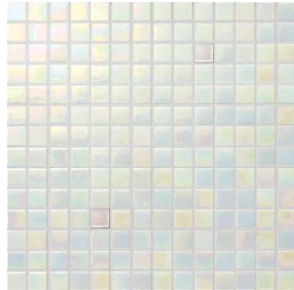

Iris Pura Platinum
20mm SM-TR796P1MOS (shown)
10mm SM-TR796P1MOS10



St Tropez Platinum
20mm SM-TR242P1MOS (shown)
10mm SM-TR242P1MOS10

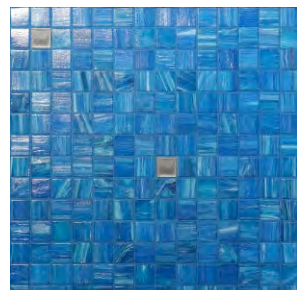

Mediterrano Platinum
20mm SM-TR244P1MOS (shown)
10mm SM-TR244P1MOS10



Sapphire Platinum
20mm SM-TR239P1MOS (shown)
10mm SM-TR239P1MOS10



Ari Atoll Gold
20mm SM-TR251G1MOS (shown)
10mm SM-TR251G1MOS10



Madulu Gold
20mm SM-TR247G1MOS (shown)
10mm SM-TR247G1MOS10

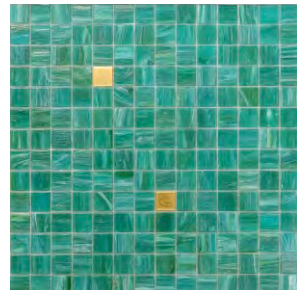

Mentha Gold
20mm SM-TR253G1MOS (shown)
10mm SM-TR253G1MOS10



Emerald Gold
20mm SM-TR236G1MOS (shown)
10mm SM-TR236G1MOS10



Ari Atoll Platinum
20mm SM-TR251P1MOS (shown)
10mm SM-TR251P1MOS10



Madulu Platinum
20mm SM-TR247P1MOS (shown)
10mm SM-TR247P1MOS10

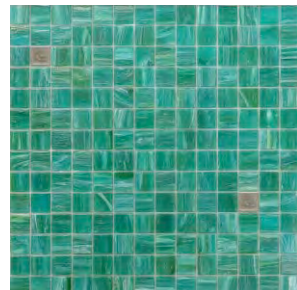

Mentha Platinum
20mm SM-TR253P1MOS (shown)
10mm SM-TR253P1MOS10



Emerald Platinum
20mm SM-TR236P1MOS (shown)
10mm SM-TR236P1MOS10

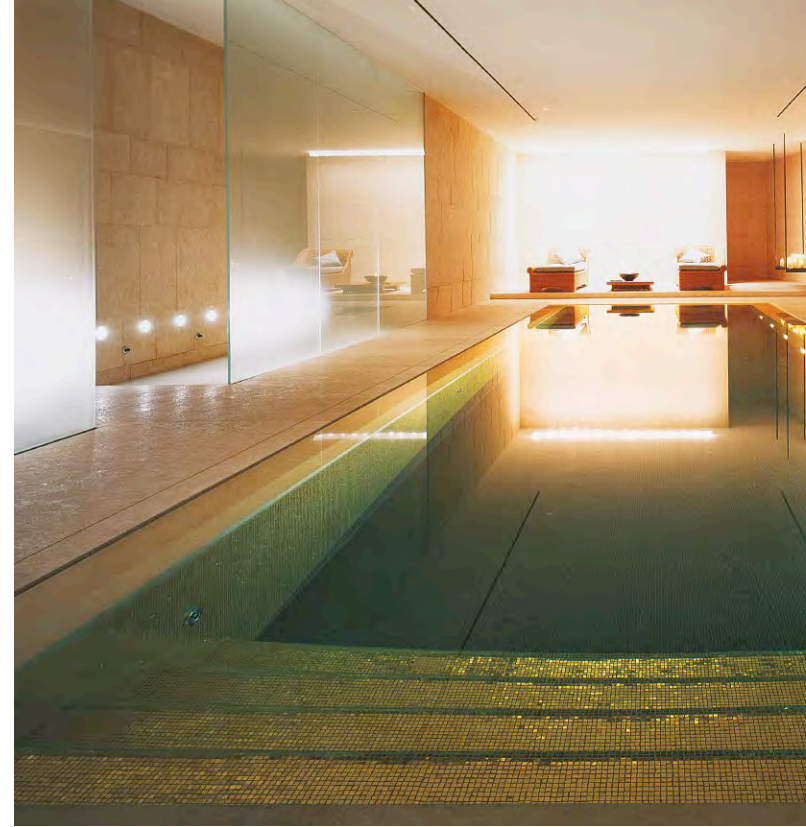

new 10mm, 20mm Trend

The enduring appeal of gold. The pieces of gold in these mixes are genuine gold leaf, encapsulated in glass to give that special glow that only comes from the real thing. And here's another interesting fact: unlike other metals, which in their pure form reflect light straight back, electrons in gold act in a way that the gold absorbs some of the blue spectrum light, giving the light that is reflected back its distinctive golden colour (see Why does my pool look blue? Page 9).

The colour mixes shown here are exclusively ours. These Trend mosaics are so new there is no installation photography to show you. Why not be the first to have a Trend Mosaic pool?



Tiger's Eye Gold
20mm SM-TR270G1MOS (shown)
10mm SM-TR270G1MOS10

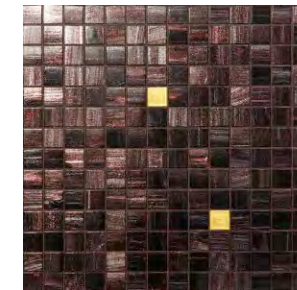

Abnoba Gold
20mm SM-TR228G1MOS (shown)
10mm SM-TR228G1MOS10



Purpura Gold
20mm SM-TR260G1MOS (shown)
10mm SM-TR260G1MOS10

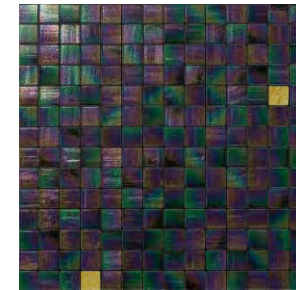

Iris Syreni Gold
20mm SM-TR798G1MOS (shown)
10mm SM-TR798G1MOS10

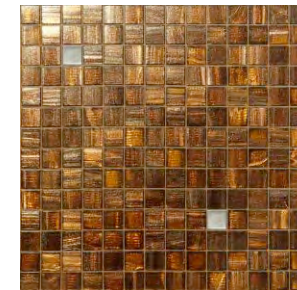

Tiger's Eye Platinum
20mm SM-TR270P1MOS (shown)
10mm SM-TR270P1MOS10

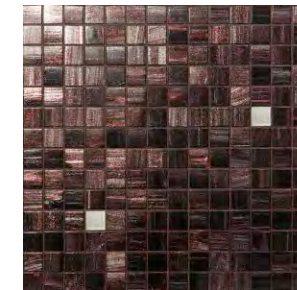

Abnoba Platinum
20mm SM-TR228P1MOS (shown)
10mm SM-TR228P1MOS10

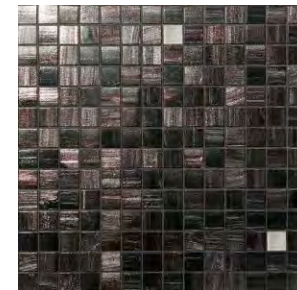

Purpura Platinum
20mm SM-TR260P1MOS (shown)
10mm SM-TR260P1MOS10

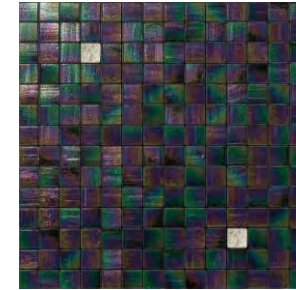

Iris Syreni Platinum
20mm SM-TR798P1MOS (shown)
10mm SM-TR798P1MOS10



Classic Paper-faced Mosaics

Traditional pool mosaics for
a classic look

Plain Glass

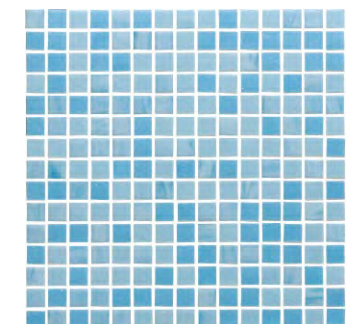

Caicos
SM-CAIMOSPF / 327 x 327 x 4mm

Iridescent Glass

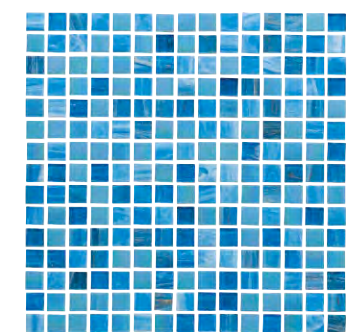

St Kitts
SM-STKMOSPF / 327 x 327 x 4mm



St Lucia
SM-STLMOSPF / 327 x 327 x 4mm



Gold fleck glass

Rich, blended colours with
glittering gold accents



Monte Cristo
GW-MOCMOSPF / 327 x 327 x 4mm

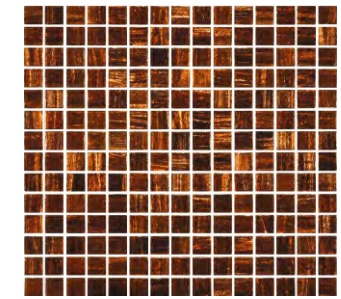

Klondike
GW-KLOMOSPF / 327 x 327 x 4mm

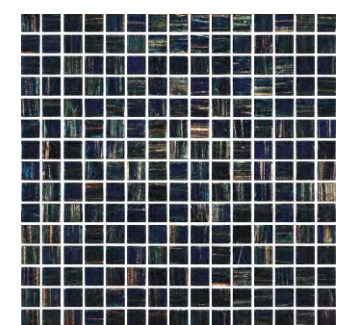

Magalia
GW-MAGMOSPF / 327 x 327 x 4mm

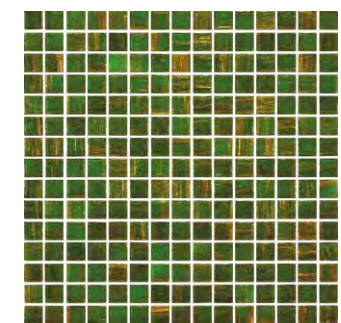

Sequoia
GW-SEQMOSPF / 327 x 327 x 4mm

POOLSIDE & SPA

Attractive, hard wearing and safe. There should be no compromise with safety when it comes to floor surfaces near pools and in wet areas. Only products that have the appropriate slip resistant qualities should be installed in these situations. But don't worry, there are plenty of options and different styles to choose from.



Highgate

600 x 300 x 10mm

Three soft stone-effect shades for walls and floors

Matt



Slip Resistant



Barefoot Wet (TRRL55 Wet) = 50

These products are available on a special order basis.

The scale of the tile swatches shown may vary between ranges.
Use the dimensions provided for an accurate gauge of size.



Beige Slip Resistant
CB05-049-6030
Beige Matt
CB05-046-6030



Taupe Slip Resistant
CB05-056-6030
Taupe Matt
CB05-053-6030

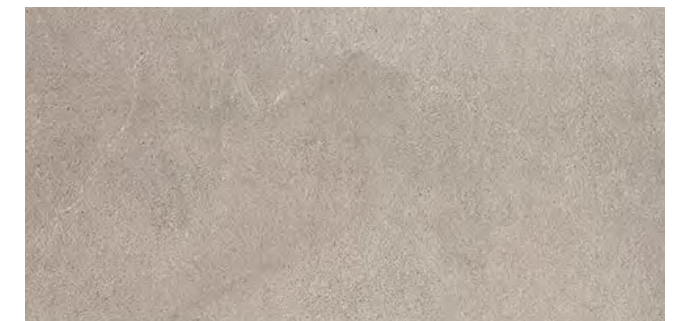

Steel Slip Resistant
CB05-063-6030
Steel Matt
CB05-060-6030

Natural Elements

A collection of colour bodied porcelain tiles in four natural-effect colours and a choice of formats, plus a 20mm thick option in selected colours

In this range:

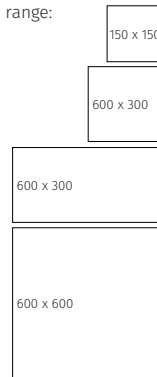

Shod Dry (4596 Dry) = 56



Barefoot Wet (TRRL55 Wet) = 42



White Slip Resistant
 CB01-031-6030 / 600 x 300 x 9mm
 CB01-031-3030 / 300 x 300 x 9mm
 CB01-031-1515 / 150 x 150 x 9mm
 20mm thick option available (see page 98)
 CB01-043-6060 / 600 x 600 x 20mm

White Matt
 CB01-030-6060 / 600 x 600 x 9mm
 CB01-030-6040 / 600 x 400 x 9mm
 CB01-030-6030 / 600 x 300 x 9mm
 CB01-030-6020 / 600 x 200 x 9mm



Beige Slip Resistant
 CB01-035-6030 / 600 x 300 x 9mm
 CB01-035-3030 / 300 x 300 x 9mm
 CB01-035-1515 / 150 x 150 x 9mm
 20mm thick option available (see page 98)
 CB01-044-6060 / 600 x 600 x 20mm

Beige Matt
 CB01-034-6060 / 600 x 600 x 9mm
 CB01-034-6030 / 600 x 300 x 9mm
 CB01-034-6030 / 600 x 300 x 9mm
 CB01-034-6020 / 600 x 200 x 9mm



Grey Slip Resistant
 CB01-023-6030 / 600 x 300 x 9mm
 CB01-023-3030 / 300 x 300 x 9mm
 CB01-023-1515 / 150 x 150 x 9mm
 20mm thick option available (see page 98)
 CB01-042-6060 / 600 x 600 x 20mm

Grey Matt
 CB01-022-6060 / 600 x 600 x 9mm
 CB01-022-6030 / 600 x 300 x 9mm

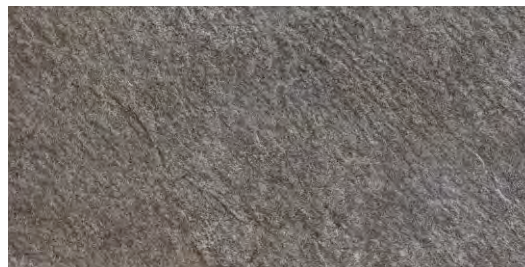

Anthracite Slip Resistant
 CB01-027-6030 / 600 x 300 x 9mm
 CB01-027-3030 / 300 x 300 x 9mm
 CB01-027-1515 / 150 x 150 x 9mm

Anthracite Matt
 CB01-026-6060 / 600 x 600 x 9mm
 CB01-026-6030 / 600 x 300 x 9mm



Natural Elements Step tread
 330 x 300mm

CB01-031-STEP White
 CB01-035-STEP Beige
 CB01-023-STEP Grey
 CB01-027-STEP Anthracite

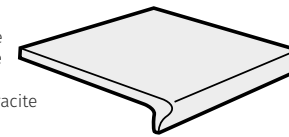

Natural Elements Rounded Coving
 300 x 170mm

CB01-031-COVE White
 CB01-035-COVE Beige
 CB01-023-COVE Grey
 CB01-027-COVE Anthracite

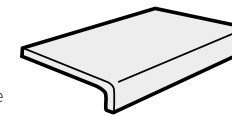

Natural Features

Similar to Natural Elements (opposite) but with a smoother, less textured surface



White Slip Resistant
 CB01-051-3030 / 600 x 300 x 10mm
 CB01-051-6030 / 600 x 600 x 10mm



Beige Slip Resistant
 CB01-053-3030 / 600 x 300 x 10mm
 CB01-053-6030 / 600 x 600 x 10mm



Grey Slip Resistant
 CB01-055-3030 / 600 x 300 x 10mm
 CB01-055-6030 / 600 x 600 x 10mm



Anthracite Slip Resistant
 CB01-057-3030 / 600 x 300 x 10mm
 CB01-057-6030 / 600 x 600 x 10mm

In this range:

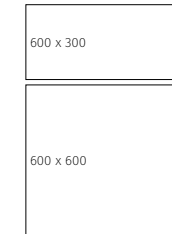

Barefoot Wet (TRRL55 Wet) = 68

These products are available on a special order basis. The scale of the tile swatches shown may vary between ranges. Use the dimensions provided for an accurate gauge of size.





Mineral

The subtle colours of these beautiful tiles look fabulous on their own or when combined together. Available in three finishes for ultimate versatility

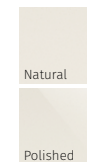
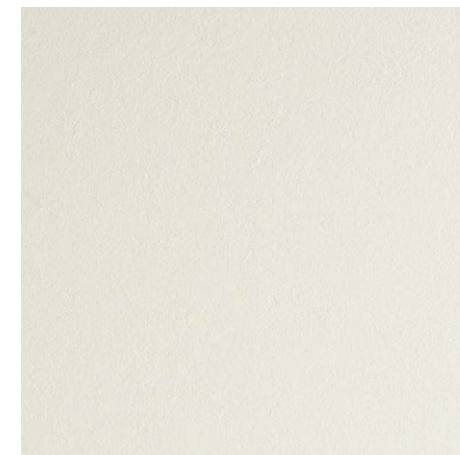

Off White Structured
 CS751-6060 / 600 x 600 x 10mm
 CS751-6030 / 600 x 300 x 10mm



Barefoot Wet (TRRL55 Wet) = 44

Off White Natural
 CS750-6060 / 600 x 600 x 10mm
 CS750-6030 / 600 x 300 x 10mm

Off White Polished
 CS752-6060 / 600 x 600 x 9mm
 CS752-6030 / 600 x 300 x 9mm



In this range:

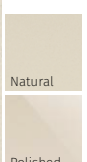
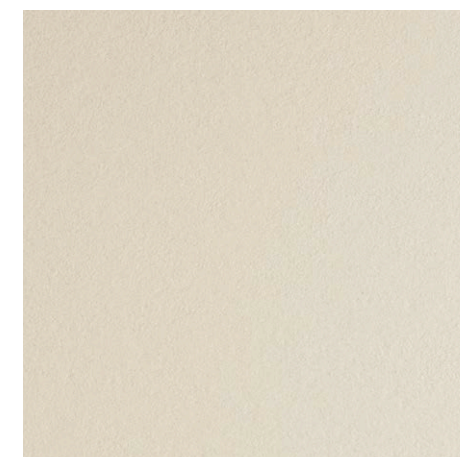
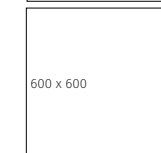

Nude Structured
 CS745-6060 / 600 x 600 x 10mm
 CS745-6030 / 600 x 300 x 10mm



Barefoot Wet (TRRL55 Wet) = 44

Nude Natural
 CS744-6060 / 600 x 600 x 10mm
 CS744-6030 / 600 x 300 x 10mm

Nude Polished
 CS746-6060 / 600 x 600 x 9mm
 CS746-6030 / 600 x 300 x 9mm

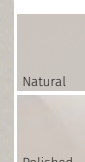
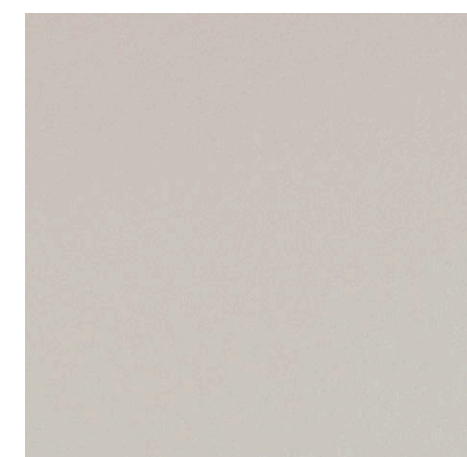

Portland Structured
 CS748-6060 / 600 x 600 x 10mm
 CS748-6030 / 600 x 300 x 10mm

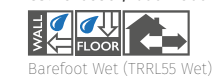

Barefoot Wet (TRRL55 Wet) = 44

Portland Natural
 CS747-6060 / 600 x 600 x 10mm
 CS747-6030 / 600 x 300 x 10mm

Portland Polished
 CS749-6060 / 600 x 600 x 9mm
 CS749-6030 / 600 x 300 x 9mm



The scale of the tile swatches shown may vary between ranges. Use the dimensions provided for an accurate gauge of size.

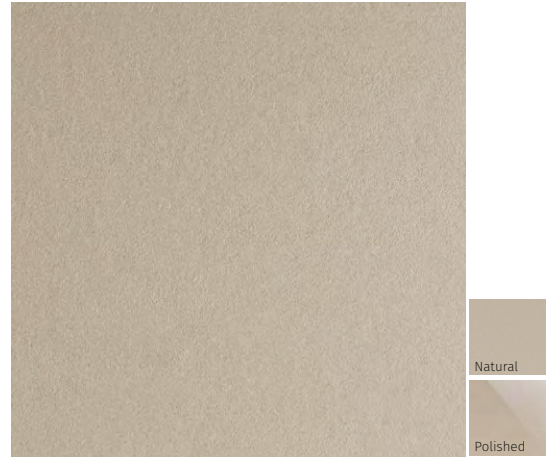

Concreteo Structured
CS736-6060 / 600 x 600 x 10mm
WALL FLOOR
Barefoot Wet (TRRL55 Wet) = 44

Concreteo Natural
CS735-6060 / 600 x 600 x 10mm
Concreteo Polished
CS737-6060 / 600 x 600 x 9mm
WALL FLOOR



Argento Structured
CS733-6060 / 600 x 600 x 10mm
WALL FLOOR
Barefoot Wet (TRRL55 Wet) = 44

Argento Natural
CS732-6060 / 600 x 600 x 10mm
Argento Polished
CS734-6060 / 600 x 600 x 9mm
WALL FLOOR



Broadway Lime Structured
CS1132-6060 / 600 x 600 x 10mm
WALL FLOOR
Barefoot Wet (TRRL55 Wet) = 59

Broadway Lime Satin
CS753-6060 / 600 x 600 x 10mm
WALL FLOOR

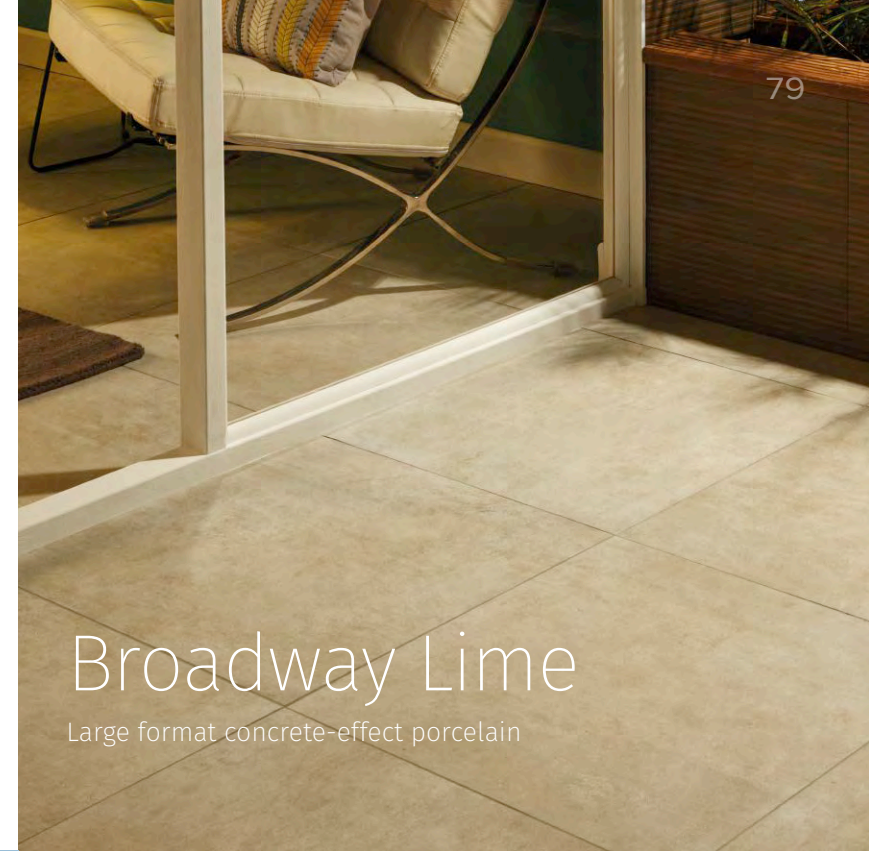

Broadway Lime
Large format concrete-effect porcelain

Mineral

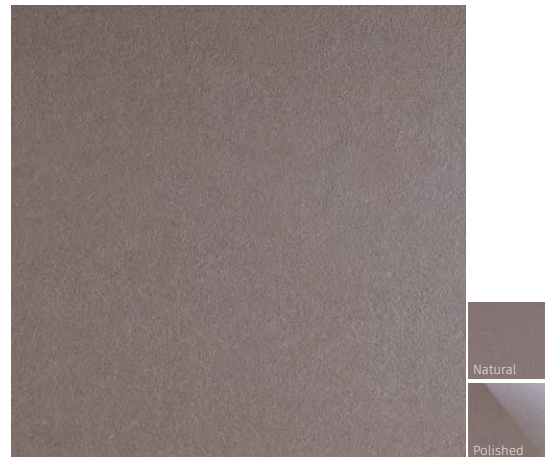

Fendi Structured
CS739-6060 / 600 x 600 x 10mm
WALL FLOOR
Barefoot Wet (TRRL55 Wet) = 44

Fendi Natural
CS738-6060 / 600 x 600 x 10mm
Fendi Polished
CS740-6060 / 600 x 600 x 9mm
WALL FLOOR

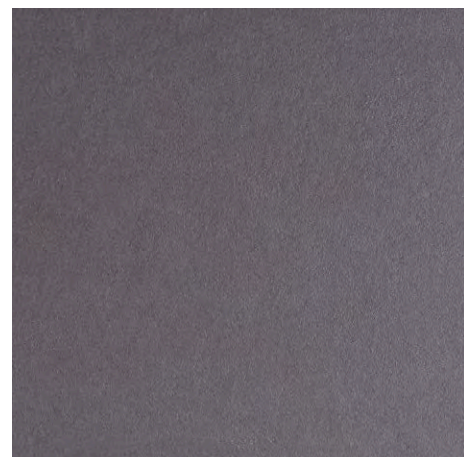

Grafito Structured
CS742-6060 / 600 x 600 x 10mm
WALL FLOOR
Barefoot Wet (TRRL55 Wet) = 44

Grafito Natural
CS741-6060 / 600 x 600 x 10mm
Grafito Polished
CS743-6060 / 600 x 600 x 9mm
WALL FLOOR

In this range:
600 x 300
600 x 600

The scale of the tile swatches shown may vary between ranges. Use the dimensions provided for an accurate gauge of size.

Slate Chiara

Glazed porcelain with the detail of natural stone



Slate Chiara Bianco Structured
CS765-6060 / 605 x 605 x 10mm
WALL FLOOR
Barefoot Wet (TRRL55 Wet) = 48

Absolute

Mix and match with a palette of muted shades from light to dark, in two versatile finishes

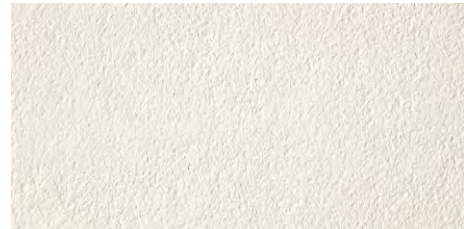

White Slate (Structured)
 CB17-028-6030 / 600 x 300 x 10mm
 CB17-028-6060 / 600 x 600 x 10mm
 CB17-028-12060 / 1200 x 600 x 10mm

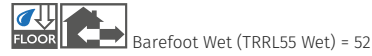

White Natural
 CB17-026-6030 / 600 x 300 x 10mm
 CB17-026-6060 / 600 x 600 x 10mm
 CB17-026-12060 / 1200 x 600 x 10mm

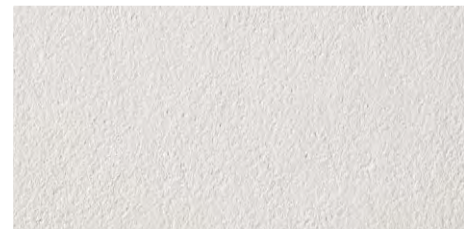

Light Grey Slate (Structured)
 CB17-024-6030 / 600 x 300 x 10mm
 CB17-024-6060 / 600 x 600 x 10mm
 CB17-024-12060 / 1200 x 600 x 10mm



Light Grey Natural
 CB17-006-6030 / 600 x 300 x 10mm
 CB17-006-6060 / 600 x 600 x 10mm
 CB17-006-12060 / 1200 x 600 x 10mm

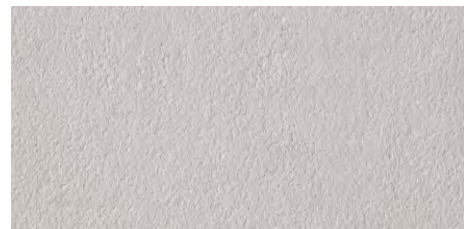

Mid Grey Slate (Structured)
 CB17-020-6030 / 600 x 300 x 10mm
 CB17-020-6060 / 600 x 600 x 10mm
 CB17-020-12060 / 1200 x 600 x 10mm



Grey Natural
 CB17-018-6030 / 600 x 300 x 10mm
 CB17-018-6060 / 600 x 600 x 10mm
 CB17-018-12060 / 1200 x 600 x 10mm



These products are available on a special order basis.
 The scale of the tile swatches shown may vary between ranges.
 Use the dimensions provided for an accurate gauge of size.

Absolute

In this range:



Grey Slate (Structured)
 CB17-016-6030 / 600 x 300 x 10mm
 CB17-016-6060 / 600 x 600 x 10mm
 CB17-016-12060 / 1200 x 600 x 10mm

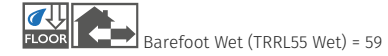

Grey Natural
 CB17-014-6030 / 600 x 300 x 10mm
 CB17-014-6060 / 600 x 600 x 10mm
 CB17-014-12060 / 1200 x 600 x 10mm

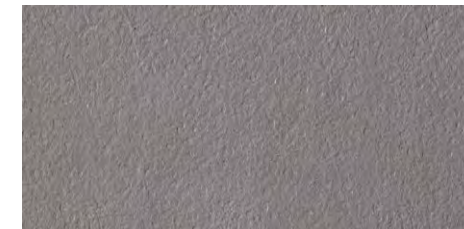
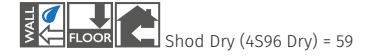

Black Slate (Structured)
 CB17-012-6030 / 600 x 300 x 10mm
 CB17-012-6060 / 600 x 600 x 10mm
 CB17-012-12060 / 1200 x 600 x 10mm

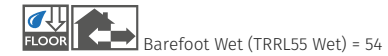

Light Grey Natural
 CB17-010-6030 / 600 x 300 x 10mm
 CB17-010-6060 / 600 x 600 x 10mm
 CB17-010-12060 / 1200 x 600 x 10mm

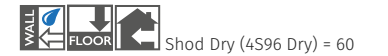

Black Slate (Structured)
 CB17-008-6030 / 600 x 300 x 10mm
 CB17-008-6060 / 600 x 600 x 10mm
 CB17-008-12060 / 1200 x 600 x 10mm



Black Natural
 CB17-006-6030 / 600 x 300 x 10mm
 CB17-006-6060 / 600 x 600 x 10mm
 CB17-006-12060 / 1200 x 600 x 10mm



These products are available on a special order basis.
 The scale of the tile swatches shown may vary between ranges.
 Use the dimensions provided for an accurate gauge of size.

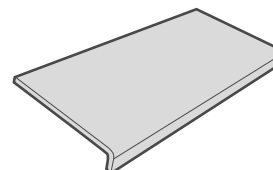

Step Edge (Structured)
600 x 325 x 10mm

CB17-028-EDGE2 White
 CB17-024-EDGE2 Light Grey
 CB17-020-EDGE2 Mid Grey
 CB17-016-EDGE2 Grey
 CB17-012-EDGE2 Dark Grey
 CB17-008-EDGE2 Black

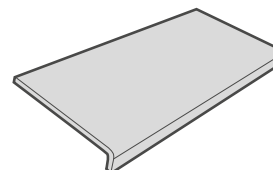

Step Edge
600 x 325 x 10mm

CB17-026-EDGE2 White
 CB17-022-EDGE2 Light Grey
 CB17-018-EDGE2 Mid Grey
 CB17-014-EDGE2 Grey
 CB17-010-EDGE2 Dark Grey
 CB17-006-EDGE2 Black

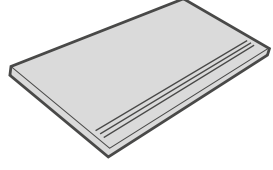

Step Tread Slate (Structured)
600 x 300 x 10mm

CB17-028-GRAD2 White
 CB17-024-GRAD2 Light Grey
 CB17-020-GRAD2 Mid Grey
 CB17-016-GRAD2 Grey
 CB17-012-GRAD2 Dark Grey
 CB17-008-GRAD2 Black

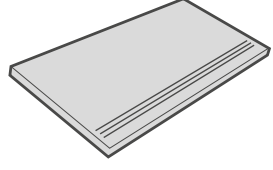

Step Tread Natural
600 x 300 x 10mm

CB17-026-GRAD2 White
 CB17-022-GRAD2 Light Grey
 CB17-018-GRAD2 Mid Grey
 CB17-014-GRAD2 Grey
 CB17-010-GRAD2 Dark Grey
 CB17-006-GRAD2 Black



Lignum

High performance wood-effect planks for wet and dry floors

1000 x 165 x 10.5mm



White Slip Resistant
CB05-026-10016
White Matt
CB05-025-10016



Cream Slip Resistant
CB05-029-10016
Cream Matt
CB05-028-10016



Beige Slip Resistant
CB05-032-10016
Beige Matt
CB05-031-10016



Grey Slip Resistant
CB05-035-10016
Grey Matt
CB05-034-10016



Taupe Slip Resistant
CB05-041-10016
Taupe Matt
CB05-040-10016



Nut Slip Resistant
CB05-044-10016
Nut Matt
CB05-043-10016



Brown Slip Resistant
CB05-038-10016
Brown Matt
CB05-037-10016

These products are available on a special order basis.



Barefoot Wet (TRRL55 Wet) = 72



Shod Dry (4596 Dry) = 63



Lignum

Step Edge (with nose)

1000 x 165mm

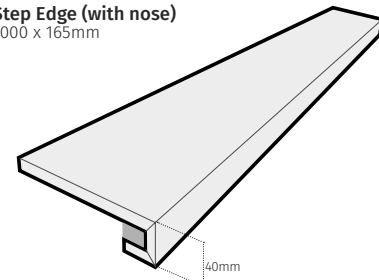

CB05-026-STEP White Slip Resistant
 CB05-029-STEP Cream Slip Resistant
 CB20-032-STEP Beige Slip Resistant
 CB20-035-STEP Grey Slip Resistant
 CB20-041-STEP Taupe Slip Resistant
 CB20-044-STEP Nut Slip Resistant
 CB20-038-STEP Brown Slip Resistant



CB05-025-STEP White
 CB05-028-STEP Cream
 CB20-031-STEP Beige
 CB20-034-STEP Grey
 CB20-040-STEP Taupe
 CB20-043-STEP Nut
 CB20-037-STEP Brown



Step Edge

1000 x 165mm

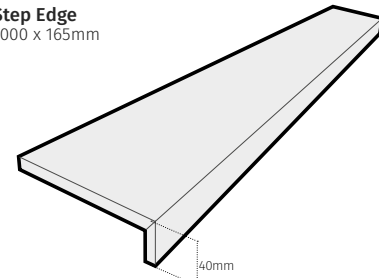

CB05-026-LSTEP White Slip Resistant
 CB05-029-LSTEP Cream Slip Resistant
 CB20-032-LSTEP Beige Slip Resistant
 CB20-035-LSTEP Grey Slip Resistant
 CB20-041-LSTEP Taupe Slip Resistant
 CB20-044-LSTEP Nut Slip Resistant
 CB20-038-LSTEP Brown Slip Resistant



CB05-025-LSTEP white
 CB05-028-LSTEP cream
 CB20-031-LSTEP beige
 CB20-034-LSTEP grey
 CB20-040-LSTEP taupe
 CB20-043-LSTEP nut
 CB20-037-LSTEP brown





Alamo

1000 x 200 x 11mm

Sandalo / Carvalo

1000 x 200 x 11mm

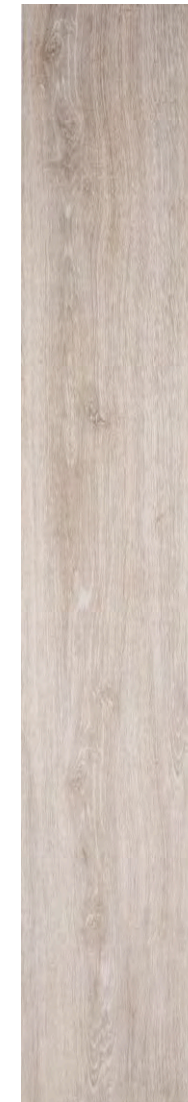

Alamo Ash Slip Resistant
CS1932-12020
Alamo Ash Matt
CS1931-12020

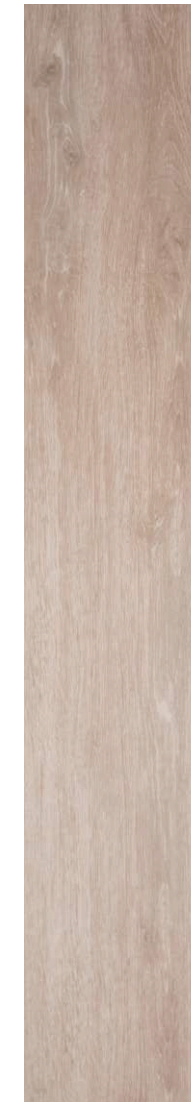

Alamo Natural Slip Resistant
CS1934-12020
Alamo Natural Matt
CS1933-12020



Sandalo Enea Slip Resistant
CS1936-12020
Sandalo Enea Matt
CS1935-12020



Carvalo Textured Slip Resistant
CS1052-12020
Carvalo Natural Matt
CS1051-12020



Barefoot Wet (TRRL55 Wet) = 45

Gatcombe

Through bodied porcelain mosaics. Dot mounted on the reverse for maximum adhesion

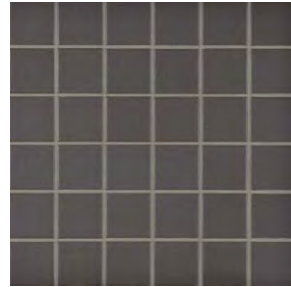

Black Square Mosaic
CS-PORBSQ / 302 x 302 x 6mm



Black & White Square Mosaic
CS-PORWSQ / 302 x 302 x 6mm



Barefoot Wet (TRRL55 Wet) = 35



White Square Mosaic
CS-PORWSQ / 302 x 302 x 6mm



Barefoot Wet (TRRL55 Wet) = 49

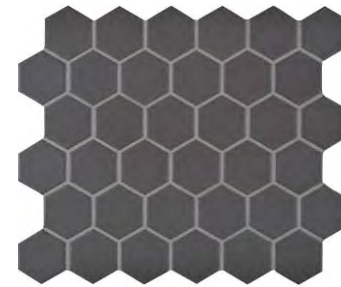

Black Hexagon Mosaic
CS-PORBHX / 322 x 278 x 6mm



Black & White Hexagon Mosaic
CS-PORWBHX / 322 x 278 x 6mm



Barefoot Wet (TRRL55 Wet) = 41



White Hexagon Mosaic
CS-PORWHX / 322 x 278 x 6mm



Barefoot Wet (TRRL55 Wet) = 40

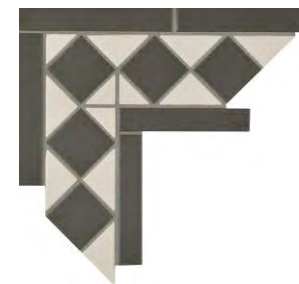

Black & White Border Corner Mosaic
CS-PORCNR / 355 x 113 x 6mm



Black & White Border Mosaic
CS-PORBDR / 355 x 113 x 6mm

The scale of the tile swatches shown may vary between ranges. Use the dimensions provided for an accurate gauge of size.

Belgravia 1200 x 600 x 10.5mm

Opulent and varied marble-effect tiles.
20mm thick options available (see page 101)

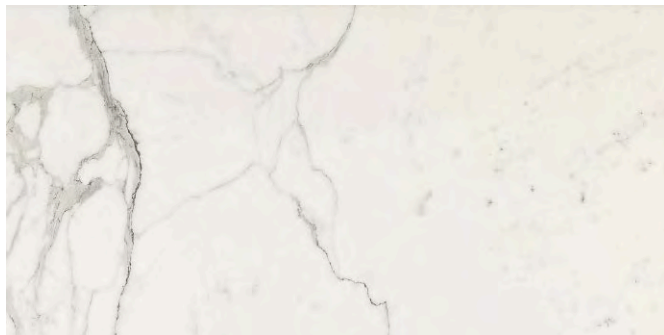

Statuario Structured
CB29-008-12060
Barefoot Wet (TRRL55 Wet) = 44



Travertino Structured
CB29-025-12060
Barefoot Wet (TRRL55 Wet) = 44



Lasa Structured
CB29-002-12060
Barefoot Wet (TRRL55 Wet) = 44

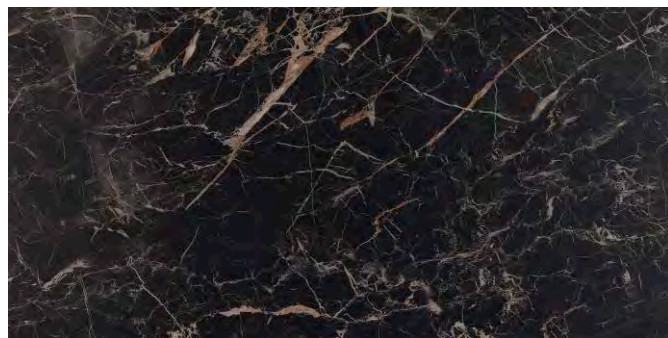

Saint Laurent Structured
CB29-031-12060
Barefoot Wet (TRRL55 Wet) = 44

These products are available on a special order basis.

The scale of the tile swatches shown may vary between ranges.
Use the dimensions provided for an accurate gauge of size.

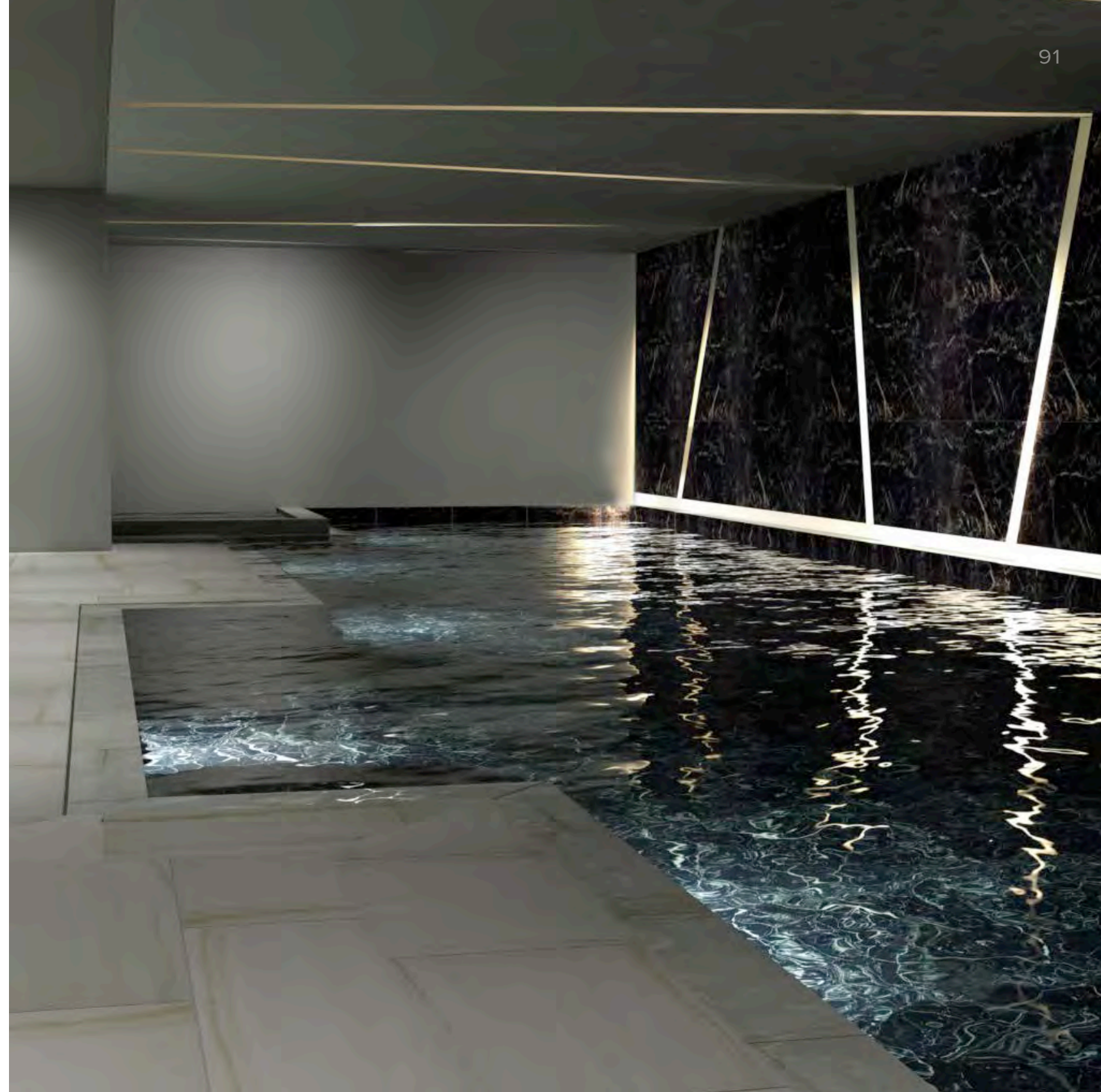



Savana

Glazed porcelain in two versatile formats



Ivory Slip Resistant
CB35-003-9045 / 900 x 450 x 9mm
CB35-003-6030 / 600 x 310 x 9mm



Grey Slip Resistant
CB35-001-9045 / 900 x 450 x 9mm
CB35-001-6030 / 600 x 310 x 9mm

In this range:

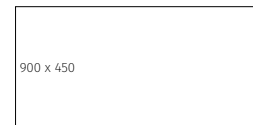

Barefoot Wet (TRRL55 Wet) = 47

Soft Earth 600 x 300 x 9mm

Three subtle shades with a gently textured surface

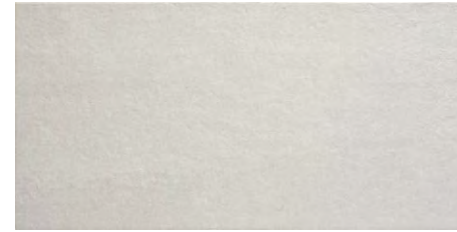

White Slip Resistant
CB35-011-6030

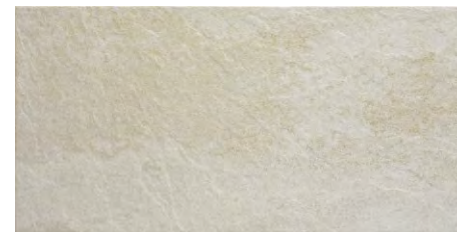

Ivory Slip Resistant
CB35-013-6030

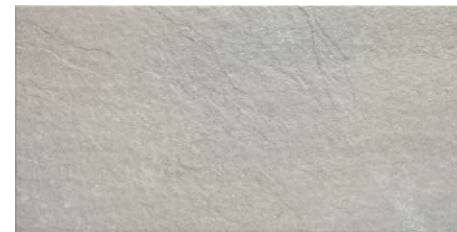

Grey Slip Resistant
CB35-016-6030



Barefoot Wet (TRRL55 Wet) = 47





Battersea 600 x 600 x 9mm

Realistic concrete effect tiles in three urban shades



White Structured
CB09-059-6060



Grey Structured
CB09-055-6060



Ash Structured
CB09-063-6060

These products are available on a special order basis.



Barefoot Wet (TRRL55 Wet) = 44



Fog Stone Slip Resistant
CB23-13S-6060 / 600 x 600 x 11mm
CB23-13S-6030 / 600 x 300 x 11mm



Barefoot Wet (TRRL55 Wet) = 51

Fog Matt
CB23-13M-6060 / 600 x 600 x 11mm
CB23-13M-6030 / 600 x 300 x 11mm



Pewter Stone Slip Resistant
CB23-04S-6060 / 600 x 600 x 11mm
CB23-04S-6030 / 600 x 300 x 11mm



Barefoot Wet (TRRL55 Wet) = 61

Pewter Matt
CB23-04M-6060 / 600 x 600 x 11mm
CB23-04M-6030 / 600 x 300 x 11mm



Iron Stone Slip Resistant
CB23-01S-6060 / 600 x 600 x 11mm
CB23-01S-6030 / 600 x 300 x 11mm



Barefoot Wet (TRRL55 Wet) = 51

Iron Matt
CB23-01M-6060 / 600 x 600 x 11mm
CB23-01M-6030 / 600 x 300 x 11mm



These products are available on a special order basis.

Gallery

High performance tiles with textured slip resistant finish for wet areas and a smooth matt option for walls and dry floors

In this range:

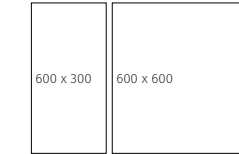

Cloud Stone Slip Resistant
CB23-11S-6060 / 600 x 600 x 11mm
CB23-11S-6030 / 600 x 300 x 11mm



Barefoot Wet (TRRL55 Wet) = 53

Cloud Matt
CB23-11M-6060 / 600 x 600 x 11mm
CB23-11M-6030 / 600 x 300 x 11mm



Shore Stone Slip Resistant
CB23-14S-6060 / 600 x 600 x 11mm
CB23-14S-6030 / 600 x 300 x 11mm



Barefoot Wet (TRRL55 Wet) = 58

Shore Matt
CB23-14M-6060 / 600 x 600 x 11mm
CB23-14M-6030 / 600 x 300 x 11mm



Denim Stone Slip Resistant
CB23-17S-6060 / 600 x 600 x 11mm
CB23-17S-6030 / 600 x 300 x 11mm



Barefoot Wet (TRRL55 Wet) = 55

Denim Matt
CB23-17M-6060 / 600 x 600 x 11mm
CB23-17M-6030 / 600 x 300 x 11mm



Ash Stone Slip Resistant
CB23-07S-6060 / 600 x 600 x 11mm
CB23-07S-6030 / 600 x 300 x 11mm



Barefoot Wet (TRRL55 Wet) = 58

Ash Matt
CB23-07M-6060 / 600 x 600 x 11mm
CB23-07M-6030 / 600 x 300 x 11mm



Surf Stone Slip Resistant
CB23-10S-6060 / 600 x 600 x 11mm
CB23-10S-6030 / 600 x 300 x 11mm



Barefoot Wet (TRRL55 Wet) = 59

Surf Matt
CB23-10M-6060 / 600 x 600 x 11mm
CB23-10M-6030 / 600 x 300 x 11mm





20mm

Tough and robust at 20mm thick, these tiles which are more like slabs are designed to withstand a great deal of wear and tear. Their rustic look is perfect for outdoor pool surrounds, coping and edgings. We can also create bespoke pieces from these thicker tiles such as grills, gradino profiles and skirtings in-house (see page 133).

Natural Elements 20mm 600 x 600 x 20mm

Standard thickness tiles available in a several formats (see page 74)



White 20mm
CB01-043-6060



Beige 20mm
CB01-044-6060



Barefoot Wet (TRRL55 Wet) = 42 / R11C



Grey 20mm
CB01-042-6060

Bespoke step with bullnose



These products are available on a special order basis.

Natural Features 20mm 600 x 600 x 20mm

Standard thickness tiles available in a several formats (see page 75)



Stone 20mm
CB01-052-6060



Sand 20mm
CB01-054-6060



Grey 20mm
CB01-050-6060



Graphite 20mm
CB01-056-6060



Barefoot Wet (TRRL55 Wet) = 68

These products are available on a special order basis.

Greenwich Park 20mm 600 x 600 x 20mm

Four natural tones with a riven texture



Sand 20mm
CB15-004-6060



Brown 20mm
CB15-006-6060



Rust 20mm
CB15-008-6060



Grey 20mm
CB15-002-6060



Barefoot Wet (TRRL55 Wet) = 49

These products are available on a special order basis.



Belgravia 20mm

1200 x 400 x 20mm

Opulent and varied marble-effect tiles.
Also available as standard thickness floor tiles
on page 90, and for feature walls on pages 126-129



Statuario 20mm
CB29-011-12040

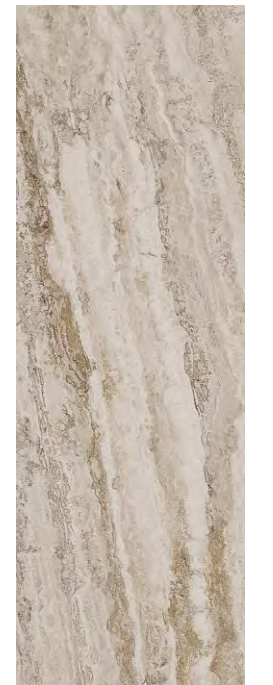

Travertino 20mm
CB29-027-12040



Barefoot Wet (TRRL55 Wet) = 47

These products are available on a special order basis.

FEATURE WALLS

Add drama with a feature wall or walls. Choose from large formats that look like stone and marble, distressed metallic effects, realistic faux wood planking and splitface natural stone.





Amelia

Three gorgeous co-ordinating colours, attractive veining effects (and minimal repeats due to a large number of faces per option) and a range of sizes make Amelia a stand out choice for walls



White
 CS1061-9015 / 890 x 145 x 10mm
 CS1061-9045 / 890 x 442 x 10mm
 CS1061-9022 / 890 x 220 x 10mm

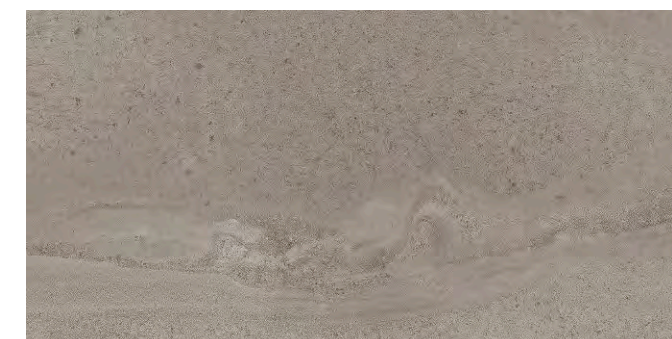

Grey
 CS1062-9015 / 890 x 145 x 10mm
 CS1062-9045 / 890 x 442 x 10mm
 CS1062-9022 / 890 x 220 x 10mm

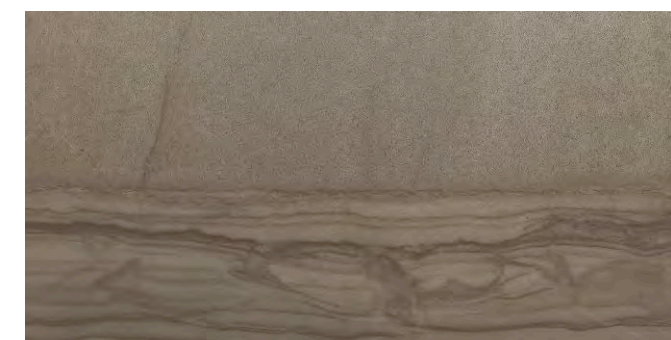

Carbon
 CS1063-9015 / 890 x 145 x 10mm
 CS1063-9045 / 890 x 442 x 10mm
 CS1063-9022 / 890 x 220 x 10mm

In this range:

- 890 x 145
- 890 x 220
- 890 x 442



The scale of the tile swatches shown may vary between ranges. Use the dimensions provided for an accurate gauge of size.

Marmi Classico

1200 x 600 x 11mm

Polished rectified glazed porcelain



Paille St. Laurent
CS1144-12060



Noir St. Laurent
CS1143-12060

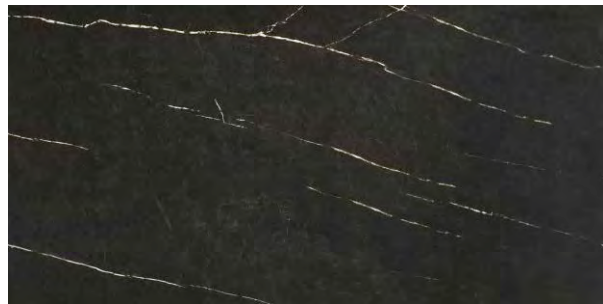

Nero Marquina
CS1634-12060



The scale of the tile swatches shown may vary between ranges. Use the dimensions provided for an accurate gauge of size.



Marmi Unici 1200 x 200 x 11mm

Matt rectified glazed porcelain



Bianco
CS1134-12020



Sabbia
CS1135-12020

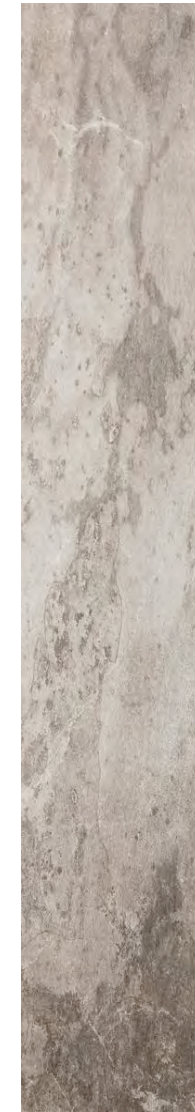

Greige
CS1136-12020

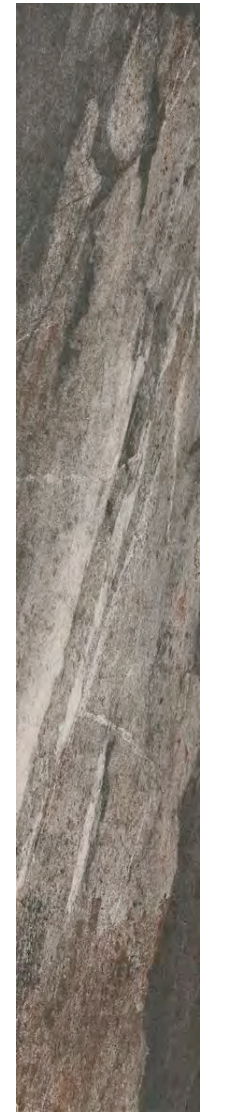

Carbone
CS1137-12020



The scale of the tile swatches shown may vary between ranges. Use the dimensions provided for an accurate gauge of size.



Oxide Semi-polished porcelain plank tiles, with a soft metallic effect 1169 x 190 x 11mm



White Lappatto
CS1120-12020



Black Lappatto
CS1121-12020





Brasilia

Matt rectified glazed porcelain

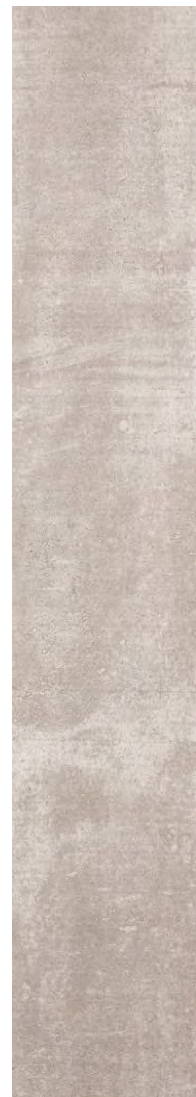

In this range:

600 x 300

600 x 600

1200 x 200

Brasilia Cinza
 CS936-12020 / 1200 x 200 x 11mm
 CS936-6060 / 600 x 600 x 10mm
 CS936-6030 / 600 x 300 x 10mm



Celaya

Matt rectified glazed porcelain

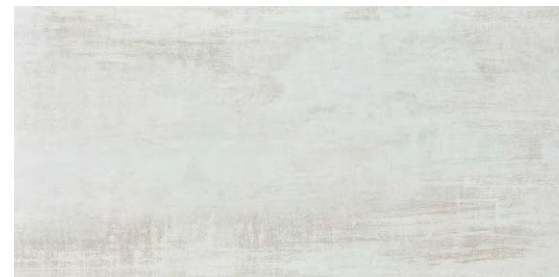

White
 CS1204-6030 / 600 x 300 x 10mm
 CS1204-6060 / 600 x 300 x 10mm



Grey
 CS1205-6030 / 600 x 300 x 10mm

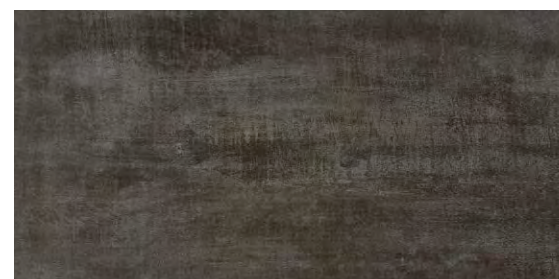

Black
 CS1206-6030 / 600 x 300 x 10mm

In this range:

600 x 300

600 x 600





Metal Effect

Metallic finish glazed porcelain

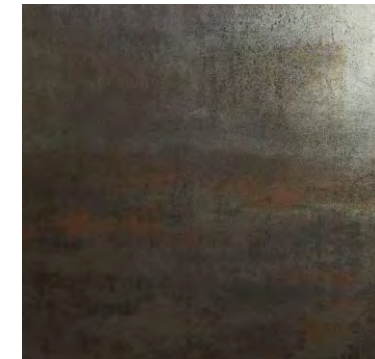

Metallic Steel
CS974-6030 / 600 x 300 x 10mm
CS974-6060 / 600 x 600 x 10mm



Metallic Copper
CS975-6030 / 600 x 300 x 10mm
CS975-6060 / 600 x 600 x 10mm

In this range:

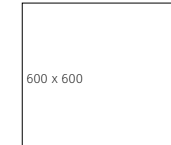
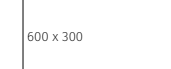

Metallic Steel Linear Mosaic
CS974-LINMOS / 300 x 300 x 10mm



Metallic Copper Linear Mosaic
CS975-LINMOS / 300 x 300 x 10mm



Steel Matt

Porcelain with the look of aged steel



Steel Matt
CS944-12060 / 1200 x 600 x 12mm



The scale of the tile swatches shown may vary between ranges. Use the dimensions provided for an accurate gauge of size.



Canela and Ash Tree

Realistic wooden clapboard-effect tiles in two colours, each with a coordinating wood-effect plank option



Ash Tree Clapboard Textured Matt Glazed Ceramic
CS1142-9030 / 900 x 300 x 12mm



Canela Clapboard Textured Matt Glazed Ceramic
CS1140-9030 / 900 x 300 x 12mm



Canela Matt Rectified Glazed Porcelain
CS1141-12020 / 1200 x 200 x 11mm



Ash Tree Matt Rectified Glazed Porcelain
CS1141-12020 / 1200 x 200 x 11mm



Painted 1169 x 190 x 11mm

Wood-effect planks with a clever reclaimed, stripped-paint style

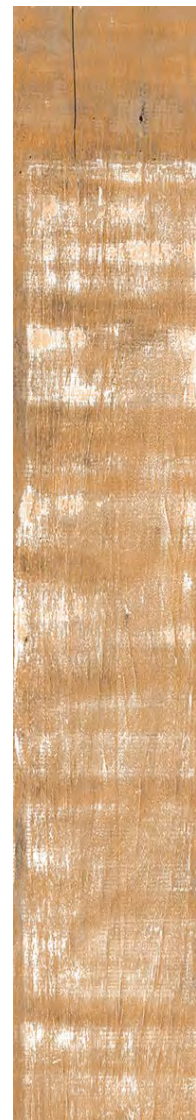

**Beige Matt Rectified
Glazed Porcelain**
CS1049-12020

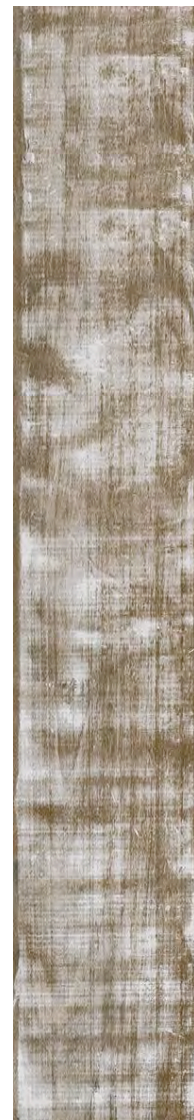

**Grey Matt Rectified Glazed
Porcelain**
CS1050-12020

Arbo Carvalho 1169 x 190 x 11mm

Intricate relief decoration over a convincing wood-effect finish



**Carvalo Décor Rectified
Glazed Porcelain**
CS1053-12020

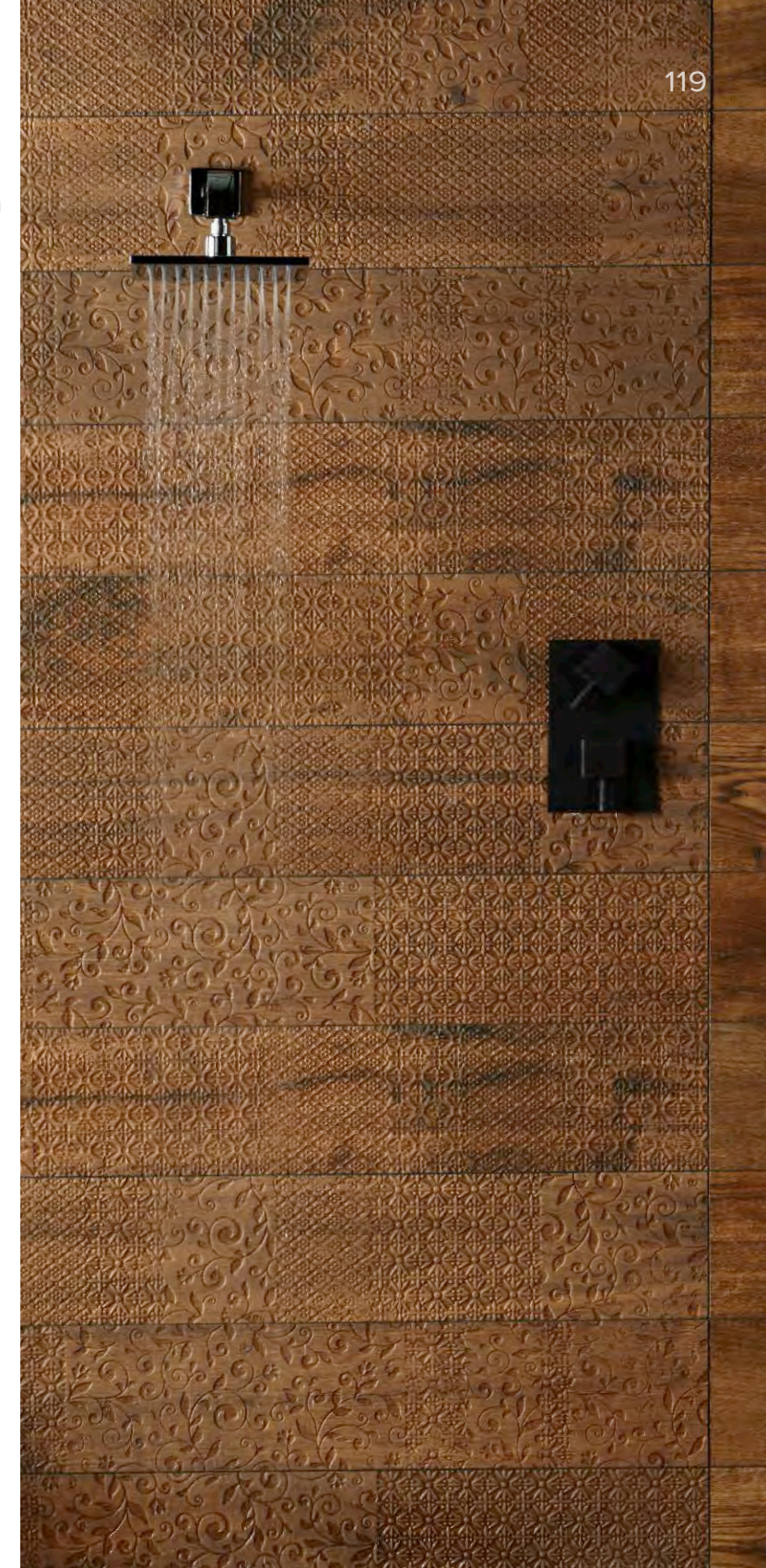



Sisal

Porcelain wall tiles with all the detail and texture of woven sisal



Sisal Rectified Glazed Porcelain
CS787-9015 / 877 x 145 x 10mm



Atenas

The appearance of split-face stone recreated on tiles



Atenas Matt Textured Porcelain
CS1044-9015 / 900 x 150 x 10mm





Splitface Stone

Natural stone interlocking mosaics for a dramatic feature wall. The quartz colours have an extra sparkling quality too



White Quartz
EW-WHQZPAN6015 / 600 x 150 x 15-20mm



Rusty Quartz
EW-RSQZPAN6015 / 600 x 150 x 15-20mm



Black Slate
EW-BLSLPAN6015 / 600 x 150 x 8-13mm

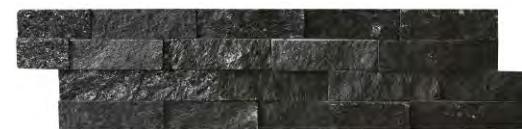

Black Quartz
EW-BLQZPAN6015 / 600 x 150 x 15-20mm



Shoreditch

Glazed porcelain tiles with a highly textured matt finish and three earthy colours for walls

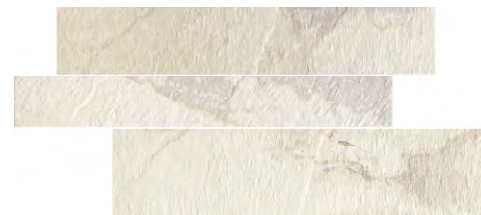

Pebble Mix
CB07-007-Mix / 300 x 600 x 11mm

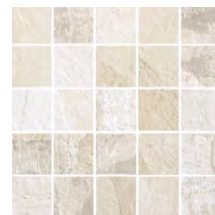

Pebble Mosaic
CB07-006-MOS / 300 x 300 x 11mm



Pebble Tredi
CB07-008-TREDI / 300 x 600 x 11mm



Fossil Mix
CB07-011-Mix / 300 x 600 x 11mm



Fossil Mosaic
CB07-010-MOS / 300 x 300 x 11mm

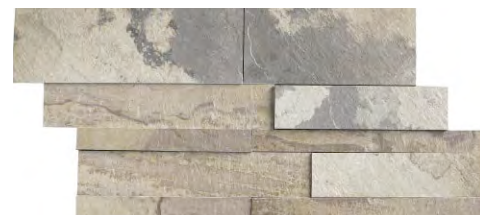

Fossil Tredi
CB07-012-TREDI / 300 x 600 x 11mm



Earth Mix
CB07-003-Mix / 300 x 600 x 11mm



Earth Mosaic
CB07-002-MOS / 300 x 300 x 11mm

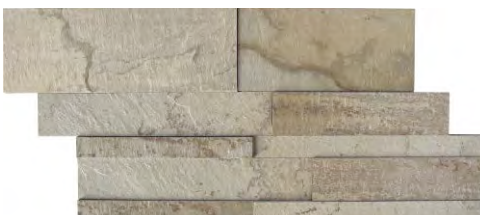

Earth Tredi
CB07-004-TREDI / 300 x 600 x 11mm

These products are available on a special order basis.
The scale of the tile swatches shown may vary between ranges.
Use the dimensions provided for an accurate gauge of size.



Belgravia

Opulent and varied marble-effect tiles.
 Floor tile options in selected colours are available on pages 90 and 103

Lasa

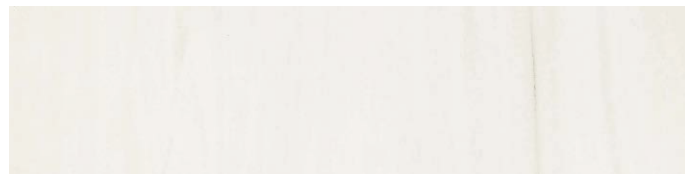

CB29-001-12030 / 1200 x 600 x 10.5mm / Rectified Matt
 CB29-003-11629 / 1160 x 290 x 10.5mm / Rectified Polished

Statuario

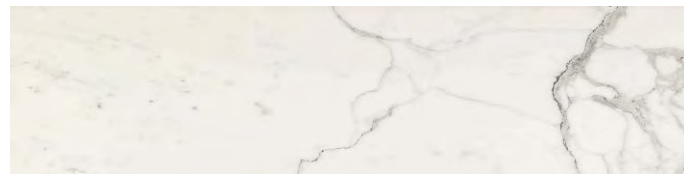

CB29-007-12030 / 1200 x 600 x 10.5mm / Rectified Matt
 CB29-009-11629 / 1160 x 290 x 10.5mm / Rectified Polished



CB29-001-12060 / 1200 x 600 x 10.5mm / Rectified Matt
 CB29-003-11658 / 1160 x 580 x 10.5mm / Rectified Polished

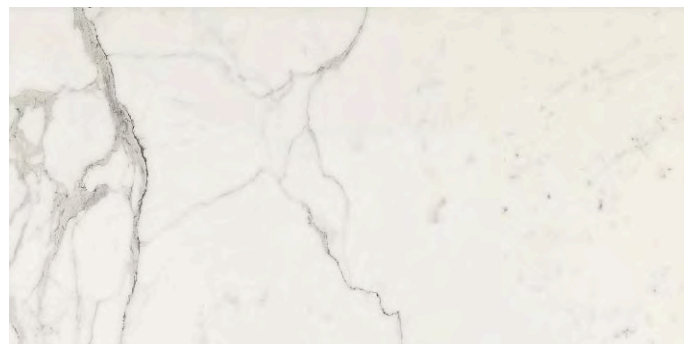

CB29-007-12060 / 1200 x 600 x 10.5mm / Rectified Matt
 CB29-009-11658 / 1160 x 580 x 10.5mm / Rectified Polished



CB29-070-6030 / 600 x 300 x 8mm
 Textured Gloss Ceramic



CB29-005-3030
 300 x 300 x 10mm
 Honed Mosaic

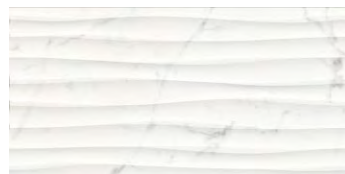

CB29-073-6030 / 600 x 300 x 8mm
 Textured Gloss Ceramic

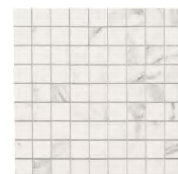

CB29-012-3030
 300 x 300 x 10mm
 Honed Mosaic



CB29-038-2118
 210 x 182 x 9.5mm
 Rectified Matt



CB29-042-2807
 280 x 70 x 10.5mm
 Rectified Matt



These products are available on a special order basis.
 The scale of the tile swatches shown may vary between ranges.
 Use the dimensions provided for an accurate gauge of size.





Belgravia

Opulent and varied marble-effect tiles.
Floor tile options in selected colours are available on pages 90 and 103

Travertino

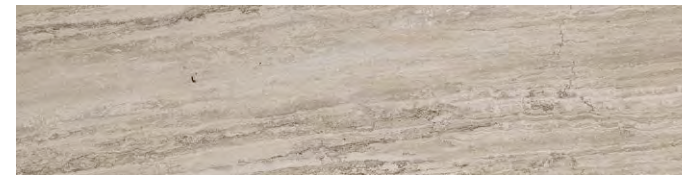

CB29-024-12030 / 1200 x 300 x 10.5mm / Rectified Matt
CB29-026-11629 / 1160 x 290 x 10.5mm / Rectified Polished

Saint Laurent

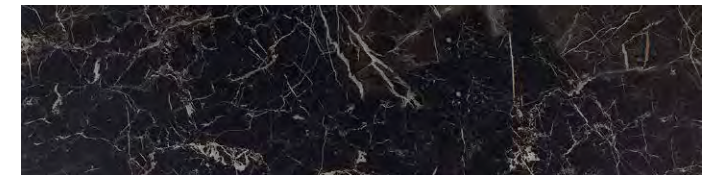

CB29-030-12030 / 1200 x 300 x 10.5mm / Rectified Matt
CB29-032-11629 / 1160 x 290 x 10.5mm / Rectified Polished



CB29-024-12060 / 1200 x 600 x 10.5mm / Rectified Matt
CB29-026-11658 / 1160 x 580 x 10.5mm / Rectified Polished

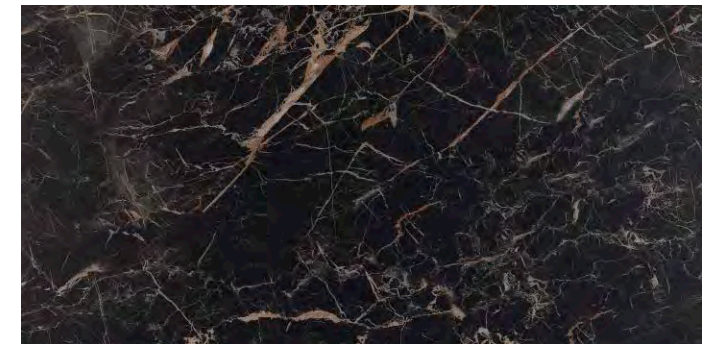

CB29-030-12060 / 1200 x 300 x 10.5mm / Rectified Matt
CB29-032-11658 / 1160 x 290 x 10.5mm / Rectified Polished



CB29-028-3030 Mosaic
300 x 300 x 10mm
Rectified Honed



CB29-043-2807
280 x 70 x 10.5mm
Rectified Matt



CB29-040-2118
210 x 182 x 9.5mm
Rectified Matt



CB29-033-3030 Mosaic
300 x 300 x 10mm
Rectified Honed



CB29-044-2807
280 x 70 x 10.5mm
Rectified Matt



These products are available on a special order basis.
The scale of the tile swatches shown may vary between ranges.
Use the dimensions provided for an accurate gauge of size.

Verres Matt rectified unglazed porcelain

Dramatic marble effects and three distinctive colour options

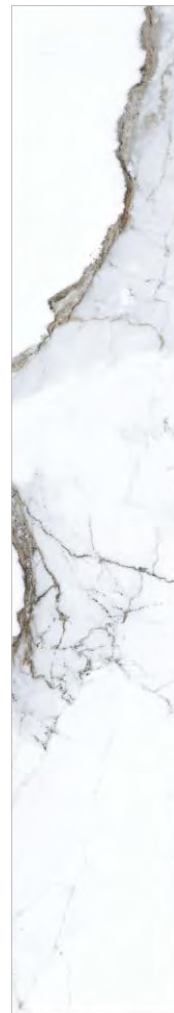

Glacier CB20-002-9015
900 x 150 x 10mm

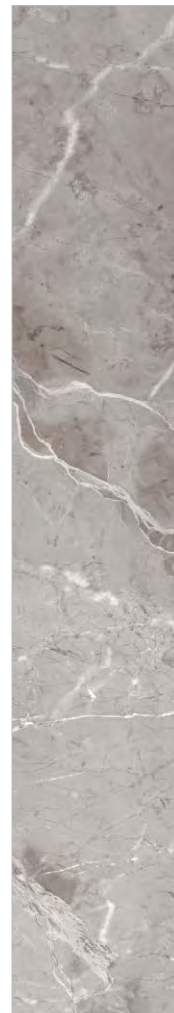

Rock CB29-003-12030
900 x 150 x 10mm



Earth CB29-001-12030
900 x 150 x 10mm

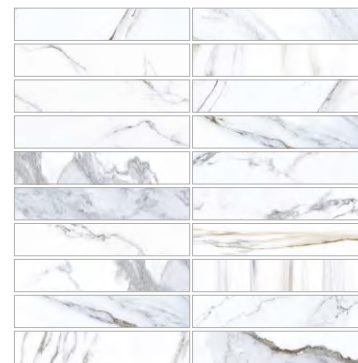

Glacier CB20-006-MOS
300 x 300 x 10mm



Rock CB20-005-MOS
300 x 300 x 10mm

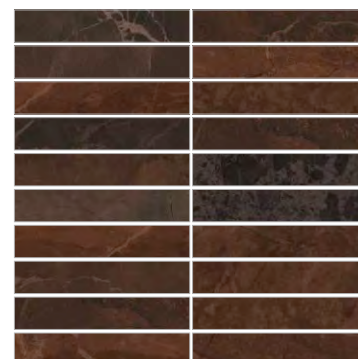

Earth CB20-004-MOS
300 x 300 x 10mm

These products are available on a special order basis.
The scale of the tile swatches shown may vary between ranges.
Use the dimensions provided for an accurate gauge of size.

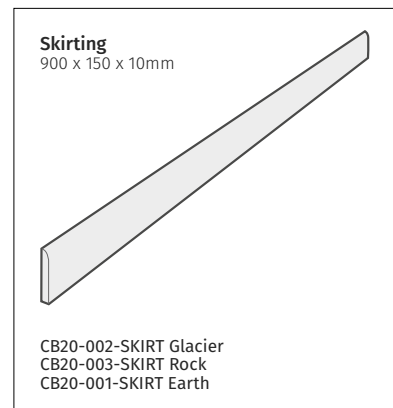

Montblanc

High gloss wall tiles with the appearance of hand crafted ceramic

White



CS1034-5020 / 500 x 200 x 9mm / Gloss Ceramic



CS1034-3007 / 300 x 75 x 9mm / Gloss Ceramic

Anthracite



CS1037-5020 / 500 x 200 x 9mm / Gloss Ceramic



CS1037-3007 / 300 x 75 x 9mm / Gloss Ceramic



CS1041-5020 / 500 x 200 x 9mm / Gloss Scored Ceramic

Pearl



CS1035-5020 / 500 x 200 x 9mm / Gloss Ceramic



CS1035-3007 / 300 x 75 x 9mm / Gloss Ceramic

Blue



CS1036-5020 / 500 x 200 x 9mm / Gloss Ceramic



CS1036-3007 / 300 x 75 x 9mm / Gloss Ceramic



CS1040-5020 / 500 x 200 x 9mm / Gloss Scored Ceramic





DETAILS

Why let the poolside let the side down?

Pool drainage hardware is traditionally metal, plastic or composite: all very useful materials that do the job, just not very pretty. For uncompromising style and a near-seamless look we can engineer drainage grilles, pool edges and bullnosed finishing pieces from the same slip resistant porcelain as the main floor.

Elevate your design from grand to sublime with a bespoke pool side solution.



Please note, bespoke drainage pieces are subject to suitability and compatibility with the chosen flooring products.



SAFETY

All tiling products used for flooring need to meet specific criteria.
Our products have passed the tests

There is a duty of care upon all flooring designers, manufacturers, distributors, installers, contractors and on the architects who specify flooring to ensure that flooring surfaces are fit for purpose and meet the Health and Safety Executive's guidelines for slip resistance.

Our tiles are tested for slip resistance and a number of other properties. Pendulum tests are carried out on our premises by our technical team, to determine the barefoot wet co-efficient of friction using a TRRL55 rubber slider.

Tile suitability is indicated on each product page of this brochure.
See overleaf for more information on slip testing methods

INFO

Sample Service

Samples and story boards are available on request.

Dimensions

Nominal sizes and thicknesses are shown throughout the brochure. All dimensions are subject to a tolerance of $\pm 2.5\text{mm}$. When calculating the number of mosaic sheets you will require, please do not forget to make 5% allowance for cutting and wastage.

Colour Variations

There may be distinctive yet subtle variations in shade in many of the mosaics and tiles included in this brochure. A single sample tile should not be taken as a completely accurate indication of colour.

Adhesives and Grouts

The water in your pool must have a pH balance of between 7.2 and 8 to eliminate acid and high alkali attacking the grout, which can cause the tiles to debond. Please be aware that all grouts have different water absorption properties. We recommend that your grout should be between 0.05% and 0.1% water absorption. Some grouts can have up to 7% water absorption, which is likely to affect the adhesion and cause the tiles to debond. Always follow the manufacturers' instructions.

Caution

Coloured grouts may be used on our mosaics, however, they may alter the overall appearance of the mosaic colour. If they are used, we strongly recommend that a small area is tested before installation. Please be aware that certain grouts are not UV resistant and will fade when placed in direct sunlight. Please contact the grout manufacturer for further advice. When installing mosaics alongside thicker tiles that are not in pools, e.g. as a border, we recommend a packing material such as P.C.I. Pedicur boards.

Pools and Power Showers

If using our tiles within a pool that has water movement e.g. flumes and slides, or if using in a shower area which has a power shower, it is important to use adhesive and grout products specified for the purpose. For further advice please contact us.

NB Original Style makes no representations as to the fitness for purpose of third party adhesives and grouts.

Glass Mosaics - Maintenance and Cleaning

Please note, the use of certain acid based cleaning products may cause some mosaics to react and change in character. Do not use hydrofluoric acid pool cleaners as these will have an adverse effect on the mosaics. We recommend the use of pH neutral cleaning products on our tiles unless stated otherwise. Regular cleaning of mosaics is recommended as a build up of certain deposits (such as magnesium and calcium) can be detrimental, even causing acid etching on the surface. These are difficult or, in some cases, impossible to remove if left.

Glass Mosaics - Scratching

As with all glass products, glass mosaics can be scratched. Care should be taken in installation and that glass mosaics are not put in high-risk areas for scratching. It is important to use a fine grade or non-sanded grout to avoid scratching the surface of glass mosaics. Glass mosaics should not be used on counter tops because of the likelihood of scratching.

Glass Mosaics - Use Near Heat Sources

Original Style recommends mosaics are installed a minimum of 3cm from any direct heat source. As glass is a very good conductor of heat caution must be taken when considering installation in areas of extreme heat.

Storage

It is important to keep all Original Style tiles and also any fixing materials such as grouts and adhesives in a cool and dry area before installation.

Photography

Owing to variations in studio lighting and printing inks, the tile colours shown in this brochure may differ slightly from those of the actual tiles. Before making your choice it is always advisable to ask for samples.

Gold Fleck and Iridescent Mosaics

The surfaces of some of the gold fleck and iridescent mosaics are very slightly pitted, which is one of their inherent features. Unless they are sealed first, any pitted surface may become unavoidably filled during the grouting process, resulting in a speckled appearance. We recommend that these tiles are sealed with a removable protective sealer prior to installation.

Please test a small inconspicuous area before installation, following all manufacturers' instructions.

Slip Resistance testing methods

Pendulum Barefoot Wet (BS7976-2 TRRL 55)

This is a swinging arm test apparatus to determine the wet coefficient of friction using a rubber slider that simulates a bare foot in wet conditions.

Accepted limits for flooring using this technique are as follows:

Slip Potential	Range
High	19 and below
Moderate	20 to 39
Low	40 to 74
Very Low	75 and above

Limits of Liability

Original Style accepts no liability for the faulty installation of its tiles. In the case of any claim relating to the tiles themselves, Original Style's liability, to the extent permitted by law, is limited to either the replacement of the product or a refund of the cost of the product, and does not extend to cover any consequential loss. Tiles must be inspected prior to installation and claims cannot be considered after the tiles have been installed. Claims must be reported within seven working days from receipt of the tiles. Tile sizes may vary slightly from the stated nominal dimensions within internationally accepted standards. Please be advised that installation constitutes acceptance of the quality, colour, texture, size and shade of the tiles. Please note the use of certain acid-based cleaning products may cause some of the tiles to react and change in character. Original Style warrants that its tiles conform to their description and are fit for their purpose. Original Style makes no representations as to the fitness for purpose of third party adhesives and grouts.







Original Style makes no other express or implied warranty as to fitness or suitability of the products for particular installations. We extend no guarantees, express or implied, as to wear resistance or maintenance procedures.

GET IN TOUCH

...by phone, email, or why not join us for a coffee and a chat at our Clerkenwell showroom?
Whatever works for you – works for us!

SHOWROOM: 91 St. John Street, London EC1M 4NU tel: 0203 751 2235
HQ: Falcon Road, Exeter, EX2 7LF tel: 01392 473037
info@designworkstiles.com / www.designworkstiles.com

Key

-  Pools & hot tubs
(suitable for submersion)
-  Walls in dry areas
-  Wet & dry walls
(inc showers & wet rooms)
-  Floors in dry areas
-  Wet & dry floors
(inc showers & wet rooms)
-  Internal use only
-  Internal & external use

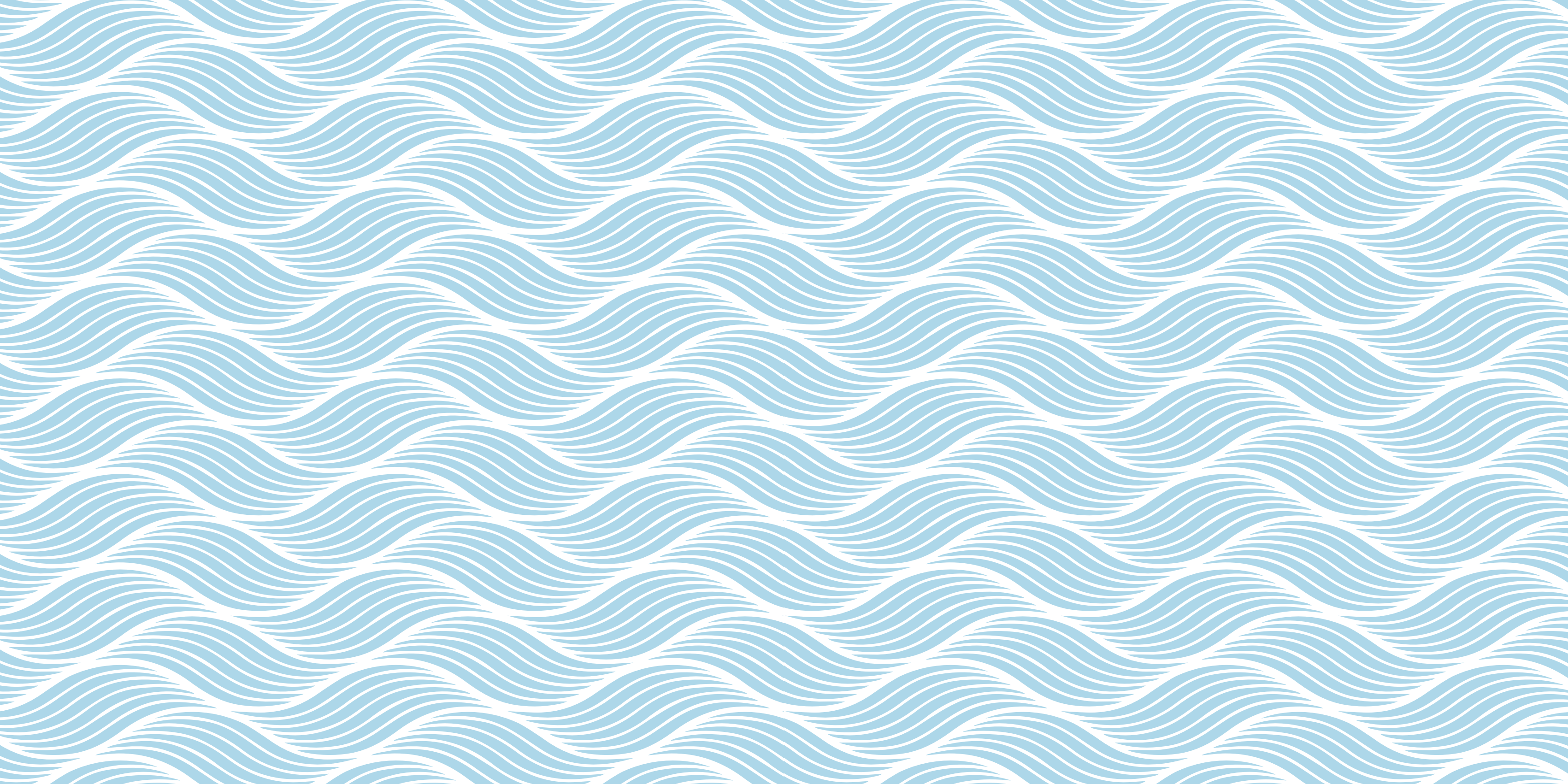

designworks:tiles

SHOWROOM: 91 St. John Street, London EC1M 4NU tel: 0203 751 2235

HQ: Falcon Road, Exeter, EX2 7LF tel: 01392 473037

info@designworkstiles.com / www.designworkstiles.com

The 'Designworks' logo is a registered trade mark of Original Style Ltd.

Original Style Limited is registered in England number 3018117.

Registered Office: Falcon Road, Sowton Industrial Estate,
Exeter, Devon, England EX2 7LF

DWULPOOL1

©Designworks Tiles 2018